

# ECS-7700/7100 USER

# Manual

Fan-less Embedded Computing System with 4 PoE+ , 2 LAN,  
1 PCI | PCIe Slots, 3<sup>rd</sup> Gen. Intel® Core™ i7 | i5 | i3 Mobile Processors

Worldwide Technical Support and Product Information

[www.vecow.com](http://www.vecow.com)

Vecow Corporate Headquarters

12F No 111 Zhongcheng Rd Tucheng Dist New Taipei City 23674 Taiwan R.O.C.

Tel: 886 2 2268 5658

Fax: 886 2 2268 1658

For further support information, refer to the Technical Support and Professional Services appendix. To comment on Vecow Co., Ltd. documentation, refer to the Vecow Co., Ltd. web site at [www.vecow.com](http://www.vecow.com).

© 2014 Vecow Co., Ltd. All rights reserved.

## Record of Revision

---

<b>Version</b>	<b>Date</b>	<b>Page</b>	<b>Description</b>	<b>Remark</b>
V1.00	December 17, 2014	All	Preliminary Release	

# Disclaimer

This manual is intended to be used as a practical and informative guide only and is subject to change without prior notice. It does not represent commitment from Vecow Co., Ltd. Vecow shall not be liable for direct, indirect, special, incidental, or consequential damages arising out of the use of the product or documentation, nor for any infringements upon the rights of third parties, which may result from such use.

## Declaration of Conformity

**FCC** This equipment has been tested and found to comply with the limits for a Class A digital device, pursuant to part 15 of the FCC Rules. These limits are designed to provide reasonable protection against harmful interference when the equipment is operated in a commercial environment. This equipment generates, uses, and can radiate radio frequency energy and, if not installed and used in accordance with the instruction manual, may cause harmful interference to radio communications. Operation of this equipment in a residential area is likely to cause harmful interference in which case the user will be required to correct the interference at his own expense.

**CE** The product(s) described in this manual complies with all applicable European Union (CE) directives if it has a CE marking. For computer systems to remain CE compliant, only CE-compliant parts may be used. Maintaining CE compliance also requires proper cable and cabling techniques.

## Copyright and Trademarks

This document contains proprietary information protected by copyright. All rights are reserved. No part of this document may be reproduced by any mechanical, electronic, or other means in any form without prior written permission of the manufacturer. Company/product names mentioned herein are used for identification

## Order Information

Part Number	Description
ECS-7710	Intel® 3 <sup>rd</sup> Gen Quad Core™ i7/i5/i3 Fanless Embedded System with 6 Gigabit Ports (4 PoE+) & 1 PCIe x16 Expansion Slot
ECS-7701	Intel® 3 <sup>rd</sup> Gen Quad Core™ i7/i5/i3 Fanless Embedded System with 6 Gigabit Ports (4 PoE+) & 1 PCI Expansion Slot
ECS-7110	Intel® 3 <sup>rd</sup> Gen Quad Core™ i7/i5/i3 Fanless Embedded System with 2 Gigabit Ports & 1 PCIe x16 Expansion Slot
ECS-7101	Intel® 3 <sup>rd</sup> Gen Quad Core™ i7/i5/i3 Fanless Embedded System with 2 Gigabit Ports & 1 PCI Expansion Slot

## Optional Accessories

Part Number	Description
M340S-W28M1	Vecow DDR3 4GB 1333/1066MHz RAM, Wide Temp. -40°C ~ +85°C
KVR1333D3S9/8G	Kingston® DDR3 8GB PC1333 RAM
KVR1333D3S9/4G	Kingston® DDR3 4GB PC1333 RAM
PWA-120WM4P	120W, 24V, 90VAC to 264VAC power adapter
SCSI-20P-100	20-pin SCSI Cable, 1M
TMB-SCSI-20P	Terminal Board with One 20-pin SCSI Connector and DIN-Rail Mounting
WiFi Module	Intel MiniPCIe WiFi Module with Antenna

# Table of Contents

<b>Disclaimer</b>	<b>iv</b>
<b>Declaration of Conformity</b>	<b>iv</b>
<b>Copyright and Trademarks</b>	<b>iv</b>
FCC	iv
CE	iv
<b>Order Information</b>	<b>v</b>
<b>Optional Accessories</b>	<b>v</b>
<b>General Introduction</b>	<b>1</b>
<b>1.1 Overview</b>	<b>1</b>
<b>1.2 Product Specification</b>	<b>2</b>
1.2.1 Specifications of Vecow ECS-7710	2
1.2.2 Specifications of Vecow ECS-7701	3
1.2.3 Specifications of Vecow ECS-7110	4
1.2.4 Specifications of Vecow ECS-7101	5
<b>1.3 Supported CPU List</b>	<b>6</b>
<b>1.4 Mechanical Dimension</b>	<b>7</b>
<b>Getting to Know Your ECS-7700/7100</b>	<b>8</b>
<b>2.1 Packing List</b>	<b>8</b>
<b>2.2 Front Panel I/O Functions</b>	<b>8</b>
2.2.1 Audio Jacks	8
2.2.2 Dual USB 3.0	9
2.2.3 Dual USB 2.0	9
2.2.4 10/100/1000 Mbps Ethernet Ports	10
2.2.5 Dual Display Port	11
2.2.6 DVI-D/HDMI Connector	11
2.2.7 VGA Connector	12
2.2.8 PWR and HDD LED Indicators	13
2.2.9 CFast Card	13
2.2.10 Power Button	14
2.2.11 Reset Tact Switch	14
<b>2.3 Rear Panel I/O Functions</b>	<b>15</b>
2.3.1 DC-In 6~36V Mini DIN or Power Terminal Block	15
2.3.2 Remote Power On/Off Switch	15
2.3.3 Serial Port COM2	16
2.3.4 Serial Port COM1, COM3 & COM4	17
2.3.5 Isolated 8 DI / 8 DO	18
2.3.6 PoE, Power over Ethernet Ports	20
<b>2.4 Main Board Expansion Connectors</b>	<b>21</b>
2.4.1 J4 Miscellaneous Pin Header	23
2.4.2 CN15, CN20, J2 LVDS	24
2.4.3 CN7, CN8 SATA3 & CN11 SATA Power Connector	27
2.4.4 CN10 SATA-II Connector J3 SATA DOM Power Connector	29
2.4.5 J1 Internal USB Dual Port	31
2.4.6 CN17, CN22 Mini-PCIe, mSATA Connectors	32
2.4.7 CN13 GPIO	34
2.4.8 FAN1	35
2.4.9 CN30 PCIe x16	36
2.4.10 Battery	38

<b>2.5 Main Board Jumper Setting</b>	<b>39</b>
2.5.1 JP2 LVDS Backlight Power Selection	41
2.5.2 JP4(A) CMOS Clear Jumper Setting	42
2.5.3 JP4(B) ME Clear Jumper Setting	43
2.5.4 JP3 AT/ATX Power Mode Jumper Setting	44
2.5.5 JP1 PCIe Bifurcation Jumper Setting	45
<b>System Setup</b>	<b>46</b>
3.1 Install DDR3 / DDR3L SODIMM Modules	46
3.2 Install HDD	47
3.3 Install MiniPCle Cards	49
3.4 Install SATA DOM	50
3.5 Install PCI or PCle Card	52
3.5 Mount Your ECS-7700/7100 series	54
<b>BIOS and Driver</b>	<b>56</b>
4.1 BIOS Settings	56
4.1.1 Main Menu	57
4.1.2 Advanced Function	57
4.1.3 Chipset Function	62
4.1.4 Boot Function	63
4.2 Operating System	63
4.3 Driver Installation	64
4.3.1 Chipset Driver Installation	64
4.3.2 Intel HD 4000 Graphics Driver Installation	65
4.3.3 Network Device Driver Installation	65
4.3.4 Audio Driver Installation	66
4.3.5 USB 3.0 Driver Installation	66
4.3.6 Storage Support Software Installation	67
4.3.7 Intel AMT Function Support	67
<b>Appendix A : Isolating DIO Guide</b>	<b>68</b>
<b>Appendix B : GPIO &amp; WDT Function</b>	<b>70</b>
A. Entry MB PnP Mode	70
B. Located on Logical Device 7	70
C. Access the Super I/O Register	70
D. Start to Access the ECS-7700/7100 Series GPIO Port	70
E.WDT ON/OFF and Timer-Counter setting	71

# 1

## General Introduction

### 1.1 Overview

Based on 3<sup>rd</sup> Gen Intel® Quad-Core™ i7 Processor (6M Cache, up to 3.30 GHz), ECS-7700/7100 series integrates 2 GbE LAN, 4 GigE PoE+ ports(ECS-7700), and one PCIe x16, or one PCI expandable slot. With maximum dual channel 16GB ram, DVI-D/HDMI and VGA triple display, two 2.5" SATA 6Gp/s HDD/SSD, one SATA 3Gp/s SSD/HDD supports SATA DOM, one of 2 miniPCI-express supports SIM card for WiFi, 3G/GPRS, and still keep outstanding thermal design for -25°C to +70°C industrial operating temperature range.

ECS-7700/7100 series provides 2 fully integrated Gigabit Ethernet interfaces for either 1000 Mb/s or 10/100 Mb/s operation rates by each and jumbo frames up to 9018 bytes. Enabling accurate time synchronization, wake-up function, and boot up through the extensible firmware interface (PXE), ECS-7700/7100 series integrates fully power management function to optimize voltage efficiency.

Empowering 4 GigE IEEE 802.3at PoE+ ports, ECS-7700 series is the ideal option for GigE cameras required efficient power supply and distances connection. Improving network traffic load-balancing by optimized parallel and pipelined architectures, the 2 gigabit Ethernet controllers of ECS-7700 series enables to smooth the network traffic loading for most demanding occasions. ECS-7700/7100 series is designed for machine vision, intelligent automation, intelligent manufacturing system, automation networking communication, IOT (Internet of Things), and process control applications.



# 1.2 Product Specification

## 1.2.1 Specifications of Vecow ECS-7710

<b>System</b>	
Processor	3 <sup>rd</sup> Generation Intel® Quad Core™ i7/i5/i3 Ivy Bridge Processors (6M Cache, up to 3.30 GHz)
Chipset	Intel® QM77
BIOS	AMI
SIO	IT8783F
Memory	DDR3 1066/1333/1600 MHz, DDR3L 1066/1333 MHz, Max. 16GB, Two 204-pin SO-DIMM Sockets
<b>I/O Ports</b>	
Serial Interface	3 COM RS-232, 1 COM RS-232 / 485 / 422
USB	4 USB 3.0, 2 USB 2.0, 2 Internal USB 2.0
Isolated DIO	8 DI, 8 DO, 5V~24V Input (Optional)
LED	Power / Suspend, HDD, CFast and and WDT LEDs
GPIO	16 GPIO
<b>Expansion</b>	
PCIe	1 Slot for PCIe x16 Expansion Card
Mini PCIe	1 miniPCIe Socket: PCIe + USB + SIM Card Socket, Optional with mSATA 1 miniPCIe Socket: PCIe + USB, Optional with mSATA
JST Connector	1 Internal 6-pin (Internal USB 2.0)
<b>Graphics</b>	
Chipset	Intel® GMA HD 4000, Triple Independent Display
Display Memory	Shared Memory, Up to 1.7GB
Interface	DB-15 VGA / 1920 x 1200 Max., DVI-D / 1920 x 1200 Max., Display Port 1 / 2560 x 1600 Max., Display Port 2 / 1920 x 1200 Max., LVDS / Dual Channel 24-bit / 1920 x 1200 Max.
<b>Storage</b>	
SATA	2 SATA III 6Gbps 1 SATA II 3Gbps - Support Horizontal Type SATA DOM
mSATA	2 SATA II 3Gbps (Optional)
Storage Expansion	CFast Slot, External Hot-Swap, Push In/Out Ejector
<b>Audio</b>	
Audio Codec	Realtek® ALC892, 5.1 Channel HD Audio
Audio Interface	Line-In, Line-Out, Mic-In, Front Audio Header
<b>Ethernet</b>	
LAN1	Intel® 82579LM Gigabit LAN, Wake on LAN, PXE Support
LAN2	Intel® 82574L Gigabit LAN
<b>Power over Ethernet</b>	
LAN3	Gigabit IEEE 802.3at (25.5W / 48V) PoE Ports by Intel® 82574L with Power On/Off Control
LAN4	Gigabit IEEE 802.3at (25.5W / 48V) PoE Ports by Intel® 82574L with Power On/Off Control
LAN5	Gigabit IEEE 802.3at (25.5W / 48V) PoE Ports by Intel® 82574L with Power On/Off Control
LAN6	Gigabit IEEE 802.3at (25.5W / 48V) PoE Ports by Intel® 82574L with Power On/Off Control
<b>Power</b>	
Power Input	1 Mini DIN, One 3-pin Terminal Block for DC-IN : V+, V-, Frame Ground
Power Input Voltage	DC-IN 6 ~ 36V
Power Adapter	AC to DC +24V / 5A 120W Max. (Optional)
Protection	On-board LT4356 for Power Input High Voltage Surge Protection
<b>Other</b>	
Trusted Platform Module (TPM)	Infineon SLB9635, LPC interface (Optional)
Watchdog Timer	Reset: 1 to 255 sec / min Per Step
HW Monitor	Temperature / Voltages Auto Throttling Control When CPU Overheats
<b>Mechanical</b>	
Chasis Construction	Aluminum Housing
Size (W x D x H)	260mm x 215mm x 79mm (10.2" x 8.5" x 3.1")
Weight	2.8 Kg (6 lb)
Mounting	Wall-mount by Mounting Bracket
<b>Environmental</b>	
Operating Temperature	-25°C to 70°C (-13°F to 157°F)
Storage Temperature	-40°C to 85°C (-40°F to 185°F)
Humidity	10% to 95% Humidity, Non-condensing
Relative Humidity	95% at 70°C
Vibration	Random: 0.5Grms @5~500 Hz according to IEC68-2-64 Sinusoidal: 0.5Grms @5~500 Hz according to IEC68-2-64
Shock	Operating, 20 Grms, Half-sine 11 ms Duration (w / SSD, According to IEC60068-2-27)
EMC	CE, FCC, RoHS, EN50155 & EN50121-3-2

## 1.2.2 Specifications of Vecow ECS-7701

<b>System</b>	
Processor	3 <sup>rd</sup> Generation Intel® Quad Core™ i7/i5/i3 Ivy Bridge Processors (6M Cache, up to 3.30 GHz)
Chipset	Intel® QM77
BIOS	AMI
SIO	IT8783F
Memory	DDR3 1066/1333/1600 MHz, DDR3L 1066/1333 MHz, Max. 16GB, Two 204-pin SO-DIMM Sockets
<b>I/O Ports</b>	
Serial Interface	3 COM RS-232, 1 COM RS-232 / 485 / 422
USB	4 USB 3.0, 2 USB 2.0, 2 Internal USB 2.0
Isolated DIO	8 DI, 8 DO, 5V~24V Input (Optional)
LED	Power / Suspend, HDD, CFast and and WDT LEDs
GPIO	16 GPIO
<b>Expansion</b>	
PCI	1 Slot for PCI Expansion Card
Mini PCIe	1 miniPCIe Socket: PCIe + USB + SIM Card Socket, Optional with mSATA 1 miniPCIe Socket: PCIe + USB, Optional with mSATA
JST Connector	1 Internal 6-pin (Internal USB 2.0)
<b>Graphics</b>	
Chipset	Intel® GMA HD 4000, Triple Independent Display
Display Memory	Shared Memory, Up to 1.7GB
Interface	DB-15 VGA / 1920 x 1200 Max., DVI-D / 1920 x 1200 Max., Display Port 1 / 2560 x 1600 Max., Display Port 2 / 1920 x 1200 Max., LVDS / Dual Channel 24-bit / 1920 x 1200 Max.
<b>Storage</b>	
SATA	2 SATA III 6Gbps 1 SATA II 3Gbps - Support Horizontal Type SATA DOM
mSATA	2 SATA II 3Gbps (Optional)
Storage Expansion	CFast Slot, External Hot-Swap, Push In/Out Ejector
<b>Audio</b>	
Audio Codec	Realtek® ALC892, 5.1 Channel HD Audio
Audio Interface	Line-In, Line-Out, Mic-In, Front Audio Header
<b>Ethernet</b>	
LAN1	Intel® 82579LM Gigabit LAN, Wake on LAN, PXE Support
LAN2	Intel® 82574L Gigabit LAN
<b>Power over Ethernet</b>	
LAN3	Gigabit IEEE 802.3at (25.5W / 48V) PoE Ports by Intel® 82574L with Power On/Off Control
LAN4	Gigabit IEEE 802.3at (25.5W / 48V) PoE Ports by Intel® 82574L with Power On/Off Control
LAN5	Gigabit IEEE 802.3at (25.5W / 48V) PoE Ports by Intel® 82574L with Power On/Off Control
LAN6	Gigabit IEEE 802.3at (25.5W / 48V) PoE Ports by Intel® 82574L with Power On/Off Control
<b>Power</b>	
Power Input	1 Mini DIN, One 3-pin Terminal Block for DC-IN : V+, V-, Frame Ground
Power Input Voltage	DC-IN 6 ~ 36V
Power Adapter	AC to DC +24V / 5A 120W Max. (Optional)
Protection	On-board LT4356 for Power Input High Voltage Surge Protection
<b>Other</b>	
Trusted Platform Module (TPM)	Infineon SLB9635, LPC interface (Optional)
Watchdog Timer	Reset: 1 to 255 sec / min Per Step
HW Monitor	Temperature / Voltages Auto Throttling Control When CPU Overheats
<b>Mechanical</b>	
Chasis Construction	Aluminum Housing
Size (W x D x H)	260mm x 215mm x 79mm (10.2" x 8.5" x 3.1")
Weight	2.8 Kg (6 lb)
Mounting	Wall-mount by Mounting Bracket
<b>Environmental</b>	
Operating Temperature	-25°C to 70°C (-13°F to 157°F)
Storage Temperature	-40°C to 85°C (-40°F to 185°F)
Humidity	10% to 95% Humidity, Non-condensing
Relative Humidity	95% at 70°C
Vibration	Random: 0.5Grms @5~500 Hz according to IEC68-2-64 Sinusoidal: 0.5Grms @5~500 Hz according to IEC68-2-64
Shock	Operating, 20 Grms, Half-sine 11 ms Duration (w / SSD, According to IEC60068-2-27)
EMC	CE, FCC, RoHS, EN50155 & EN50121-3-2

## 1.2.3 Specifications of Vecow ECS-7110

<b>System</b>	
Processor	3 <sup>rd</sup> Generation Intel® Quad Core™ i7/i5/i3 Ivy Bridge Processors (6M Cache, up to 3.30 GHz)
Chipset	Intel® QM77
BIOS	AMI
SIO	IT8783F
Memory	DDR3 1066/1333/1600 MHz, DDR3L 1066/1333 MHz, Max. 16GB, Two 204-pin SO-DIMM Sockets
<b>I/O Ports</b>	
Serial Interface	3 COM RS-232, 1 COM RS-232 / 485 / 422
USB	4 USB 3.0, 2 USB 2.0, 2 Internal USB 2.0
LED	Power / Suspend, HDD, CFast and and WDT LEDs
GPIO	16 GPIO
<b>Expansion</b>	
PCIe	1 Slot for PCIe x16 Expansion Card
Mini PCIe	1 miniPCIe Socket: PCIe + USB + SIM Card Socket, Optional with mSATA 1 miniPCIe Socket: PCIe + USB, Optional with mSATA
JST Connector	1 Internal 6-pin (Internal USB 2.0)
<b>Graphics</b>	
Chipset	Intel® GMA HD 4000, Triple Independent Display
Display Memory	Shared Memory, Up to 1.7GB
Interface	DB-15 VGA / 1920 x 1200 Max., DVI-D / 1920 x 1200 Max., Display Port 1 / 2560 x 1600 Max., Display Port 2 / 1920 x 1200 Max., LVDS / Dual Channel 24-bit / 1920 x 1200 Max.
<b>Storage</b>	
SATA	2 SATA III 6Gbps 1 SATA II 3Gbps - Support Horizontal Type SATA DOM
mSATA	2 SATA II 3Gbps (Optional)
Storage Expansion	CFast Slot, External Hot-Swap, Push In/Out Ejector
<b>Audio</b>	
Audio Codec	Realtek® ALC892, 5.1 Channel HD Audio
Audio Interface	Line-In, Line-Out, Mic-In, Front Audio Header
<b>Ethernet</b>	
LAN1	Intel® 82579LM Gigabit LAN, Wake on LAN, PXE Support
LAN2	Intel® 82574L Gigabit LAN
<b>Power</b>	
Power Input	1 Mini DIN, One 3-pin Terminal Block for DC-IN : V+, V-, Frame Ground
Power Input Voltage	DC-IN 6 ~ 36V
Power Adapter	AC to DC +24V / 5A 120W Max. (Optional)
Protection	On-board LT4356 for Power Input High Voltage Surge Protection
<b>Other</b>	
Trusted Platform Module (TPM)	Infineon SLB9635, LPC interface (Optional)
Watchdog Timer	Reset: 1 to 255 sec / min Per Step
HW Monitor	Temperature / Voltages Auto Throttling Control When CPU Overheats
<b>Mechanical</b>	
Chasis Construction	Aluminum Housing
Size (W x D x H)	260mm x 215mm x 79mm (10.2" x 8.5" x 3.1")
Weight	2.8 Kg (6 lb)
Mounting	Wall-mount by Mounting Bracket
<b>Environmental</b>	
Operating Temperature	-25°C to 70°C (-13°F to 157°F)
Storage Temperature	-40°C to 85°C (-40°F to 185°F)
Humidity	10% to 95% Humidity, Non-condensing
Relative Humidity	95% at 70°C
Vibration	Random: 0.5Grms @5~500 Hz according to IEC68-2-64 Sinusoidal: 0.5Grms @5~500 Hz according to IEC68-2-64
Shock	Operating, 20 Grms, Half-sine 11 ms Duration (w / SSD, According to IEC60068-2-27)
EMC	CE, FCC, RoHS, EN50155 & EN50121-3-2

## 1.2.4 Specifications of Vecow ECS-7101

<b>System</b>	
Processor	3 <sup>rd</sup> Generation Intel® Quad Core™ i7/i5/i3 Ivy Bridge Processors (6M Cache, up to 3.30 GHz)
Chipset	Intel® QM77
BIOS	AMI
SIO	IT8783F
Memory	DDR3 1066/1333/1600 MHz, DDR3L 1066/1333 MHz, Max. 16GB, Two 204-pin SO-DIMM Sockets
<b>I/O Ports</b>	
Serial Interface	3 COM RS-232, 1 COM RS-232 / 485 / 422
USB	4 USB 3.0, 2 USB 2.0, 2 Internal USB 2.0
LED	Power / Suspend, HDD, CFast and and WDT LEDs
GPIO	16 GPIO
<b>Expansion</b>	
PCI	1 Slot for PCI Expansion Card
Mini PCIe	1 miniPCIe Socket: PCIe + USB + SIM Card Socket, Optional with mSATA 1 miniPCIe Socket: PCIe + USB, Optional with mSATA
JST Connector	1 Internal 6-pin (Internal USB 2.0)
<b>Graphics</b>	
Chipset	Intel® GMA HD 4000, Triple Independent Display
Display Memory	Shared Memory, Up to 1.7GB
Interface	DB-15 VGA / 1920 x 1200 Max., DVI-D / 1920 x 1200 Max., Display Port 1 / 2560 x 1600 Max., Display Port 2 / 1920 x 1200 Max., LVDS / Dual Channel 24-bit / 1920 x 1200 Max.
<b>Storage</b>	
SATA	2 SATA III 6Gbps 1 SATA II 3Gbps - Support Horizontal Type SATA DOM
mSATA	2 SATA II 3Gbps (Optional)
Storage Expansion	CFast Slot, External Hot-Swap, Push In/Out Ejector
<b>Audio</b>	
Audio Codec	Realtek® ALC892, 5.1 Channel HD Audio
Audio Interface	Line-In, Line-Out, Mic-In, Front Audio Header
<b>Ethernet</b>	
LAN1	Intel® 82579LM Gigabit LAN, Wake on LAN, PXE Support
LAN2	Intel® 82574L Gigabit LAN
<b>Power</b>	
Power Input	1 Mini DIN, One 3-pin Terminal Block for DC-IN : V+, V-, Frame Ground
Power Input Voltage	DC-IN 6 ~ 36V
Power Adapter	AC to DC +24V / 5A 120W Max. (Optional)
Protection	On-board LT4356 for Power Input High Voltage Surge Protection
<b>Other</b>	
Trusted Platform Module (TPM)	Infineon SLB9635, LPC interface (Optional)
Watchdog Timer	Reset: 1 to 255 sec / min Per Step
HW Monitor	Temperature / Voltages Auto Throttling Control When CPU Overheats
<b>Mechanical</b>	
Chasis Construction	Aluminum Housing
Size (W x D x H)	260mm x 215mm x 79mm (10.2" x 8.5" x 3.1")
Weight	2.8 Kg (6 lb)
Mounting	Wall-mount by Mounting Bracket
<b>Environmental</b>	
Operating Temperature	-25°C to 70°C (-13°F to 157°F)
Storage Temperature	-40°C to 85°C (-40°F to 185°F)
Humidity	10% to 95% Humidity, Non-condensing
Relative Humidity	95% at 70°C
Vibration	Random: 0.5Grms @5~500 Hz according to IEC68-2-64 Sinusoidal: 0.5Grms @5~500 Hz according to IEC68-2-64
Shock	Operating, 20 Grms, Half-sine 11 ms Duration (w / SSD, According to IEC60068-2-27)
EMC	CE, FCC, RoHS, EN50155 & EN50121-3-2

## 1.3 Supported CPU List

Vecow ECS-7700/7100 series accepts 3<sup>rd</sup> generation Intel® i7/i5/i3 processors via a rPGA988B CPU socket. The following processors have been tested by Vecow Co., Ltd. for the compatibility with Vecow ECS-7700/7100 series . Instead of i7-3610QE, i5-3610ME and i3-3120ME, You may also select other processor according to your consideration of application and performance.

Series		Max. TDP	iAMT	Embedded
i7	3840QM	45W	√	
	3820QM	45W	√	
	3740QM	45W	√	
	3720QM	45W	√	
	3632QM	35W		
	3630QM	45W		
	3612QM	35W		
	<b>3610QE</b>	<b>45W</b>	√	<b>O</b>
	3610QM	45W		
	3540M	35W	√	
	3520M	35W	√	
i5	<b>3610ME</b>	<b>35W</b>	√	<b>O</b>
	3380M	35W	√	
	3360M	35W	√	
	3340M	35W	√	
	3320M	35W	√	
	3230M	35W		
	3210M	35W		
i3	3130M*	35W		
	<b>3120ME</b>	<b>35W</b>		<b>O</b>
	3120M*	35W		
	3110M*	35W		

The processors with "O" are listed in Intel® Embedded Roadmap and with a 7-year life cycle support (from 2011 to 2017). The processors with "\*" the maximum operation temperature is 55°C.

# 1.4 Mechanical Dimension

Figure 1.1 ECS-7710 & ECS-7701 Dimension

Unit: mm (inch)

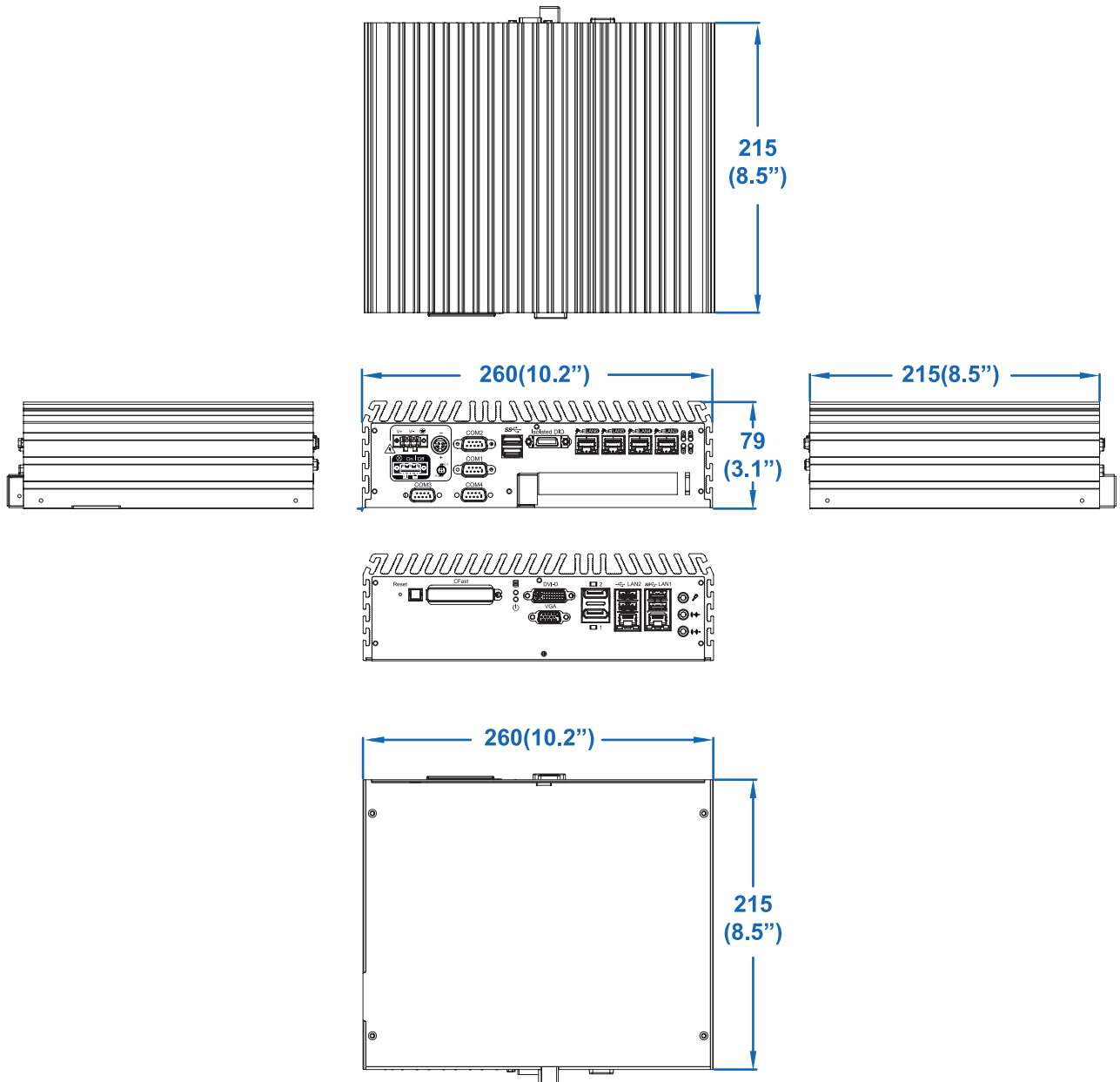

# 2

## Getting to Know Your ECS-7700/7100

### 2.1 Packing List

Item	Description	Qty
1	ECS-7700/7100 fanless controller (According to the configuration you order, the ECS-7700/7100 may contain HDD and DDR3 SO-DIMM. Please verify these items if necessary.)	1
2	Accessory box, which contains <ul style="list-style-type: none"><li>• Vecow Drivers &amp; Utilities DVD</li><li>• Wall-mounting bracket</li><li>• M4 screws for wall-mounting bracket</li><li>• 3-pin pluggable terminal block</li></ul>	1 2 4 2

### 2.2 Front Panel I/O Functions

#### 2.2.1 Audio Jacks

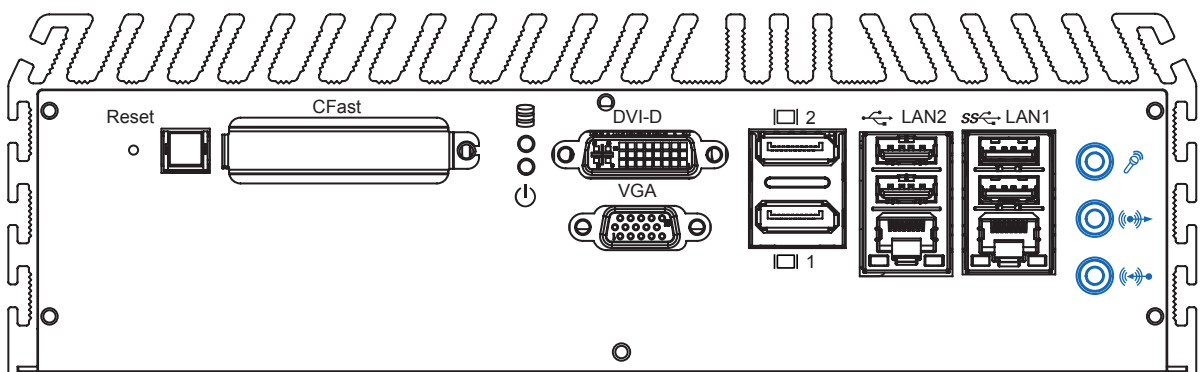

The ECS-7700/7100 series offers stereo audio connector of MIC , Line\_In and Line\_Out. The audio chip controller is by ALC892 which is compliant with the Intel® Azalia standard. To utilize the audio function in Windows, you need to install corresponding drivers for both Intel QM77 chipset and Realtek ALC892 codec. Please refer to Section 4 for information of driver installation.

### 2.2.2 Dual USB 3.0

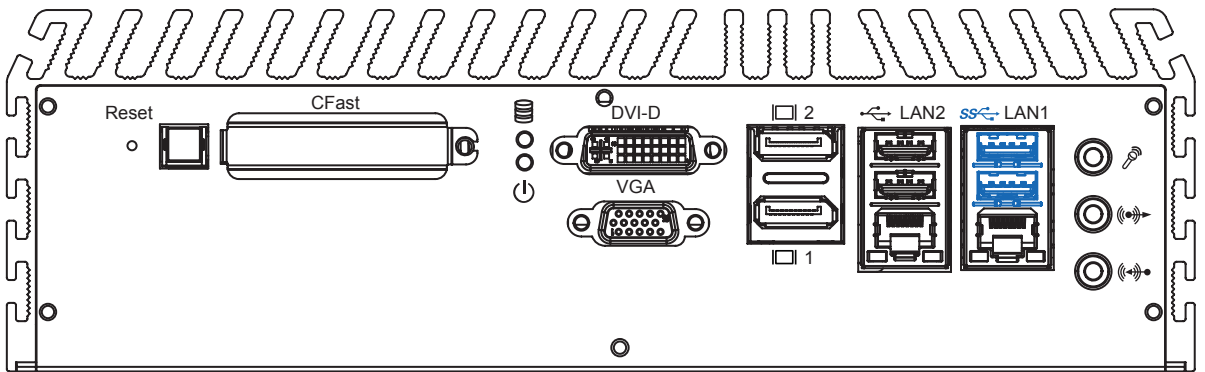

The ECS-7700/7100 series comes with 2 USB 3.0 hosts on the front panel and 2 hosts on the rear panel. These USB 3.0 ports allow data transfers up to 5 Gb/s. The controller supports SuperSpeed (SS), high-speed (HS), full-speed (FS) and low-speed (LS) traffic on the bus.

### 2.2.3 Dual USB 2.0

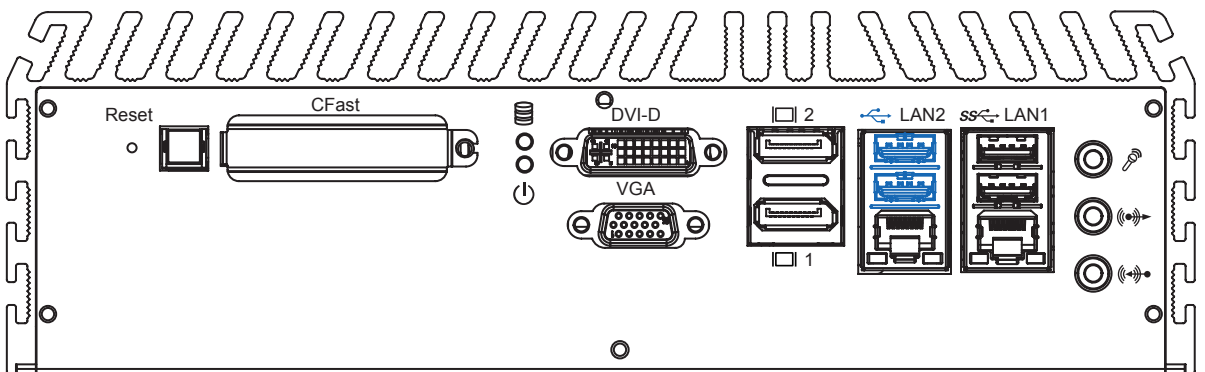

The ECS-7700/7100 series comes with 2 USB 2.0 hosts on the front panel. The USB interface supports Plug and Play, which enables you to connect or disconnect a device whenever you want, without turning off the system. The hosts can be used for an external flash disk or hard drive for storing large amounts of data. You can also use these USB hosts to connect to a keyboard or a mouse. The following diagram shows the pinouts for USB1 and USB2 port.

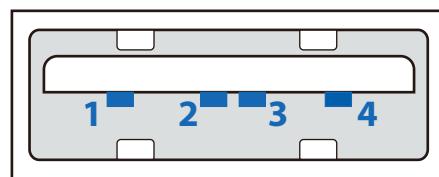

Pin Number	1	2	3	4
USB1	+5V	USB1-	USB1+	GND
USB2	+5V	USB2-	USB2+	GND



## 2.2.4 10/100/1000 Mbps Ethernet Ports

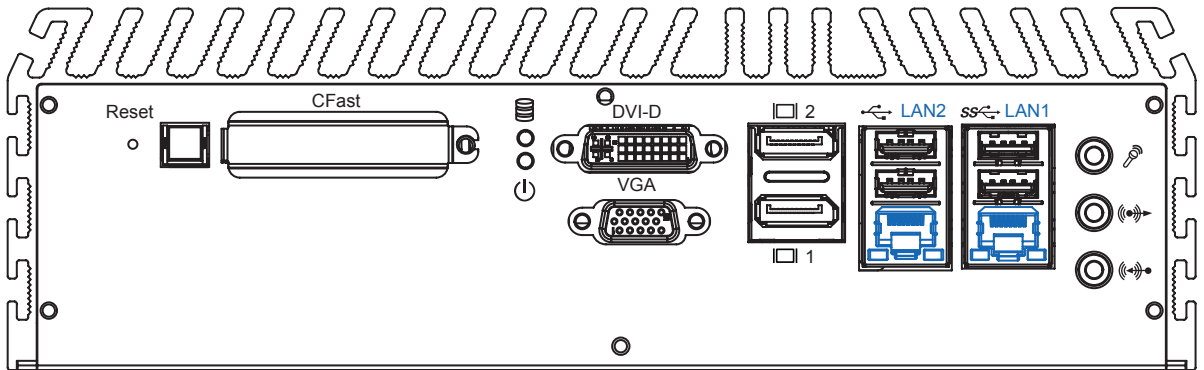

The 10/100/1000 Mbps Ethernet LAN ports 1 and 2 use 8-pin RJ-45 connector. LAN1 is equipped with Intel 82579LM for AMT function. LAN2 is equipped with Intel 82574L. Using suitable RJ-45 cable, you can connect ECS-7700/7100 series system to a computer, or to any other piece of equipment that has an Ethernet connection, for example, a hub or a switch. Moreover, both of them have Wake-on-LAN and Preboot Execution Environment capabilities. The following diagram shows the pinouts for LAN1 and LAN2 port.

Pin No.	10 / 100 Mbps	1000 Mbps
1	E_TX+	MDI0_P
2	E_TX-	MDI0_N
3	E_RX+	MDI1_P
4	----	MDI2_P
5	-----	MDI2_N
6	E_RX-	MDI1_N
7	-----	MDI3_P
8	-----	MDI3_N

The Ethernet ports use standard RJ-45 jack connectors with LED indicators on the front side to show Active/Link status and Speed status. The LED indicators on the right bottom corners glow a solid green color when the cable is properly connected to a 100 Mbps Ethernet network. The LED indicator on the left bottom corner will flash on and off when Ethernet packets are being transmitted or received.

The LED indicators on the right bottom corners glow a solid orange color when the cable is properly connected to a 1000 Mbps Ethernet network. The LED indicator on the left bottom corner will flash on and off when Ethernet packets are being transmitted or received.

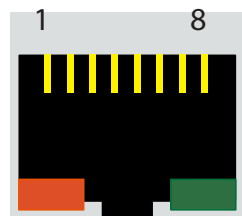

Location	10 Mbps	100 Mbps	1000 Mbps
Right Bottom LED	off	Solid Green	Solid Orange
Left Bottom LED	Flash Yellow	Flash Yellow	Flash Yellow

## 2.2.5 Dual Display Port

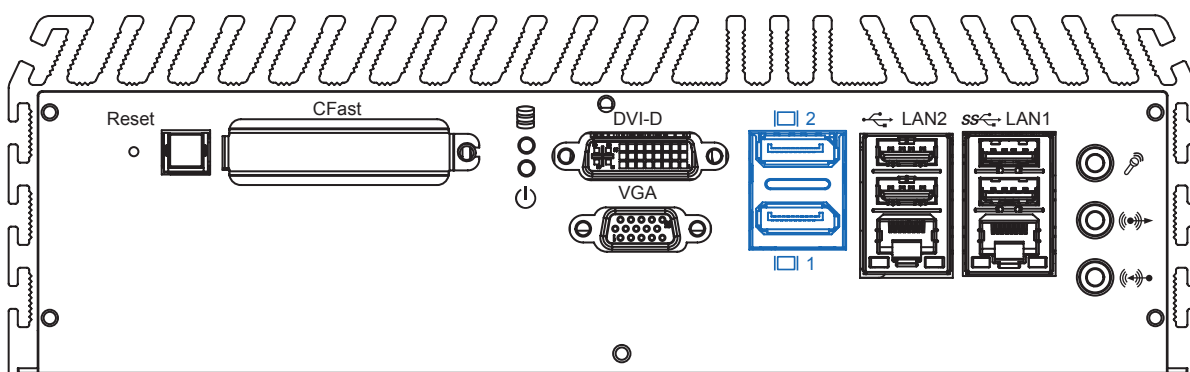

Each digital port is capable of driving resolutions up to 2560x1600 at 60 Hz through Display Port.

## 2.2.6 DVI-D/HDMI Connector

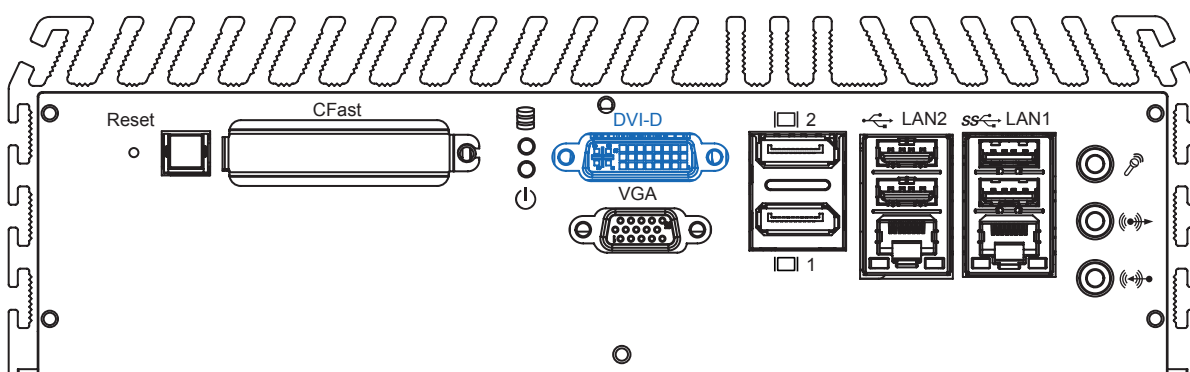

The DVI-D connector on the front panel supports both DVI and HDMI operation mode. This connector can either output DVI signals or HDMI signal. The DVI output mode supports up to 1920x1200 resolutions and HDMI output mode supports up to 1920x1200 resolutions. The DVI or HDMI mode is automatically selected according to the display device connected. You shall need a DVI-D to HDMI cable when connecting to a HDMI display device.

## 2.2.7 VGA Connector

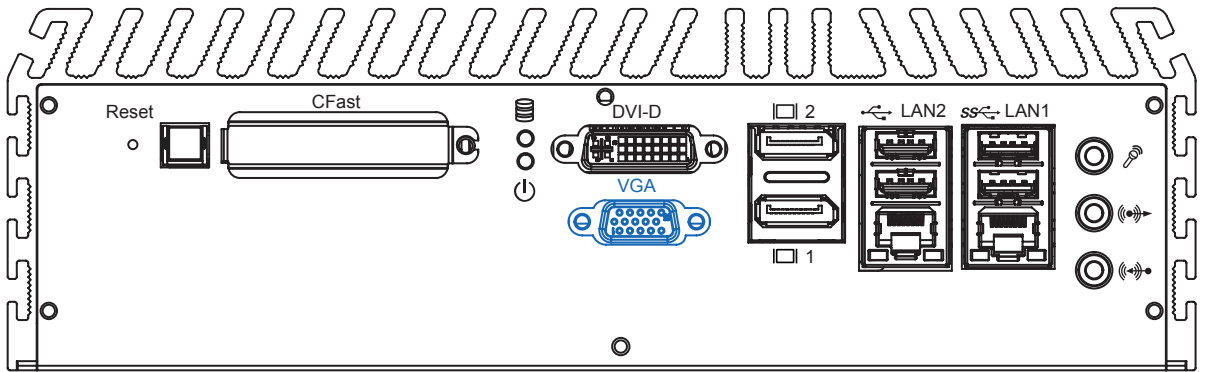

The ECS-7700/7100 series comes with a DB15 female connector on the front panel to connect a VGA monitor. To ensure that the monitor image remains clear, be sure to tighten the monitor cable after connecting it to the ECS-7700/7100 series. The VGA output mode supports up to 1920x1200 resolutions. The pin assignments of the VGA connector are shown below.

Pin No.	Description
1	Red Color Signal
2	Green Color Signal
3	Blue Color Signal
4	NC
5	Ground
6	VGA Detect
7	Ground
8	Ground
9	VCC
10	Ground
11	NC
12	DDC-DATA
13	H-Sync.
14	V-Sync.
15	DDC-CLK

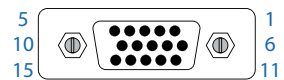

## 2.2.8 PWR and HDD LED Indicators

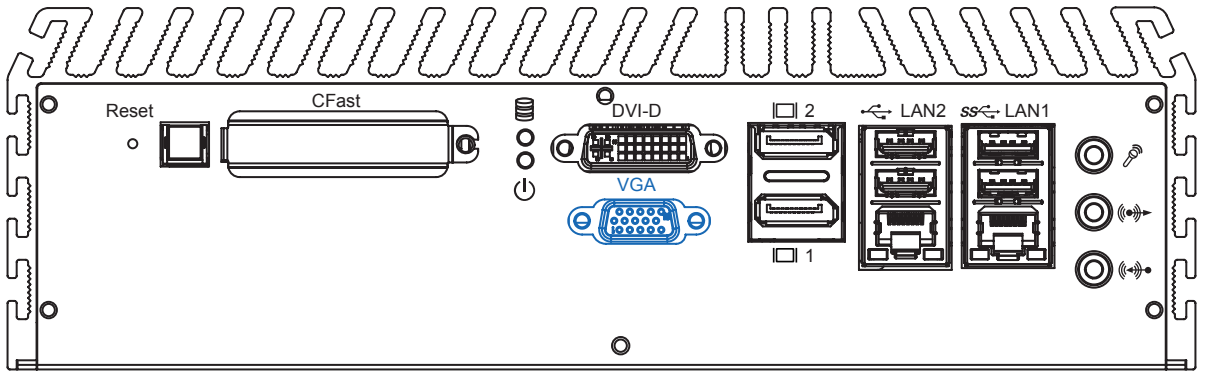

**Yellow-HDD LED:** A hard disk / CFast LED. If the LED is on, it indicates that the system's storage is functional. If it is off, it indicates that the system's storage is not functional. If it is flashing, it indicates data access activities.

**Green-Power LED:** If the LED is solid green, it indicates that the system is powered on.

## 2.2.9 CFast Card

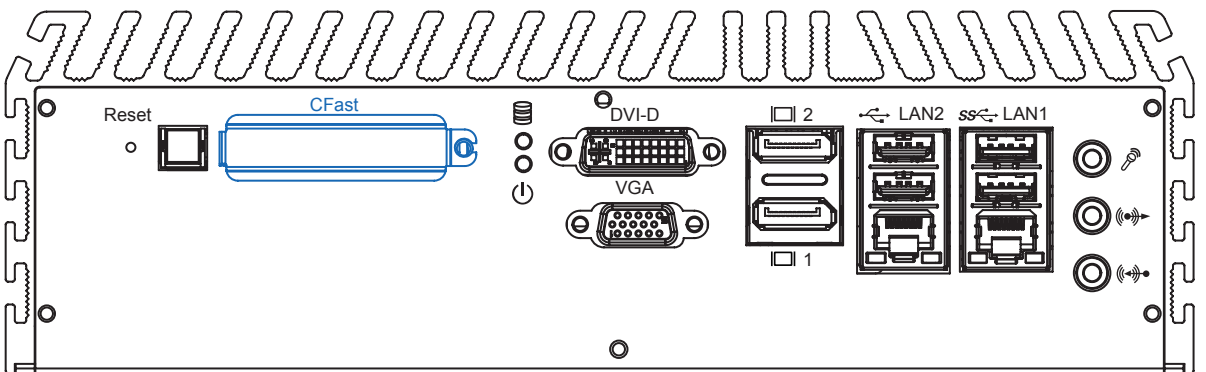

The ECS-7700/7100 series system comes with a CFast socket on the front panel for Type-I / Type-II Compact Flash card. It is implemented by a SATA II Port from QM77 PCH. Be sure to disconnect the power source and unscrew the CFast socket cover before installing a CFast card. The ECS-7700/7100 series does not support the CFast hot swap and PnP (Plug and Play) functions. It is necessary to remove power source first before inserting or removing the CFast card. The following table shows the pinouts for CFast port:

Pin No.	Description	Pin No.	Description	Pin No.	Description
S1	GND	PC2	GND	PC10	NC
S2	SATA_TX_P2	PC3	NC	PC11	NC
S3	SATA_TX_N2	PC4	NC	PC12	NC
S4	GND	PC5	NC	PC13	+3.3V
S5	SATA_RX_N2	PC6	NC	PC14	+3.3V
S6	SATA_RX_P2	PC7	GND	PC15	GND
S7	GND	PC8	NC	PC16	GND
PC1	NC	PC9	CFAST_LED_N	PC17	NC

## 2.2.10 Power Button

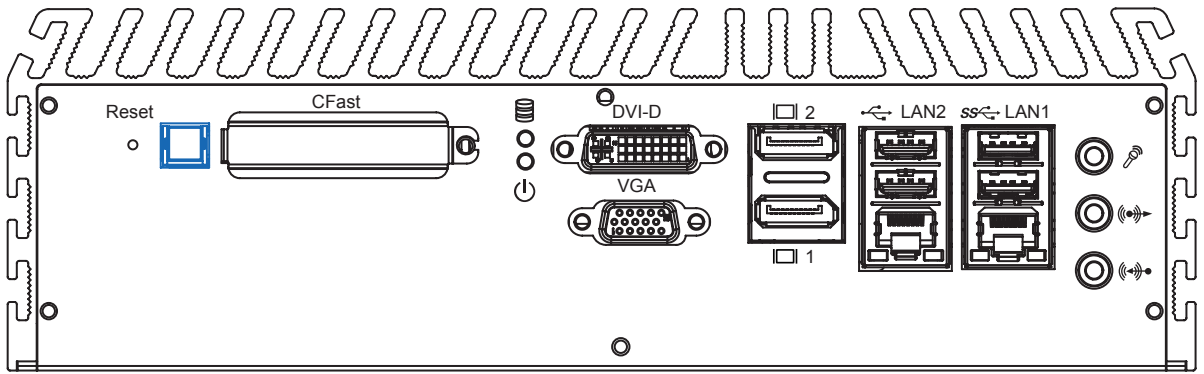

The power button is a non-latched switch with dual color LED (Blue/Orange) for indication S0, S3 and S5 status. Power button dual-color LED indicator:

Status	LED Display	System Situation
S0	Solid Blue	System working
S3, S5	Solid Orange	Suspend to RAM, System off with standby power

To turn on the ECS-7700/7100 series, press the power button and the blue LED is lighted up. To turn off the ECS-7700/7100 series, you can either issue a shutdown command in OS, or just simply press the power button.

In case of system halts, you can press and hold the power button for 4 seconds to compulsorily shut down the system. Please note that a 4 seconds interval is kept by the system between two on/off operations (i.e. once turning off the system, you shall wait for 4 seconds to initiate another power-on operation).

## 2.2.11 Reset Tact Switch

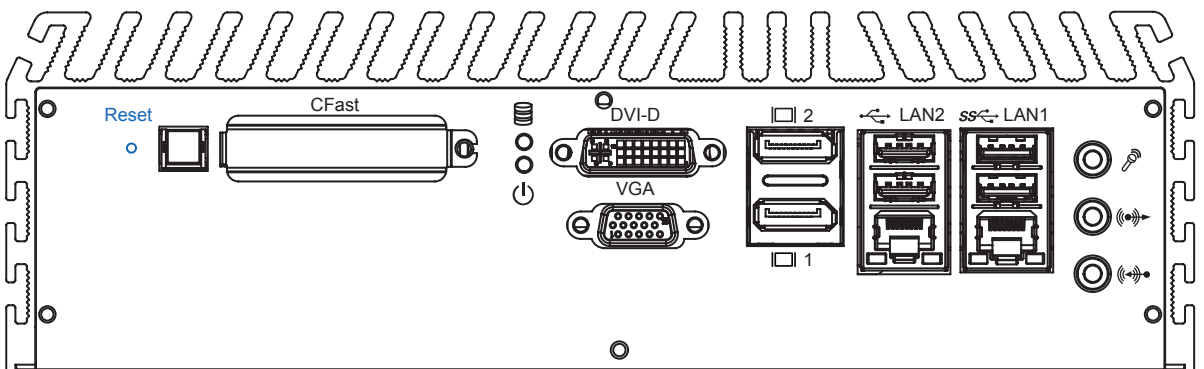

It is a hardware reset switch. Use this switch to reset the system without turning off the power. Momentarily pressing the switch will activate a reset.

## 2.3 Rear Panel I/O Functions

### 2.3.1 DC-In 6~36V Mini DIN or Power Terminal Block

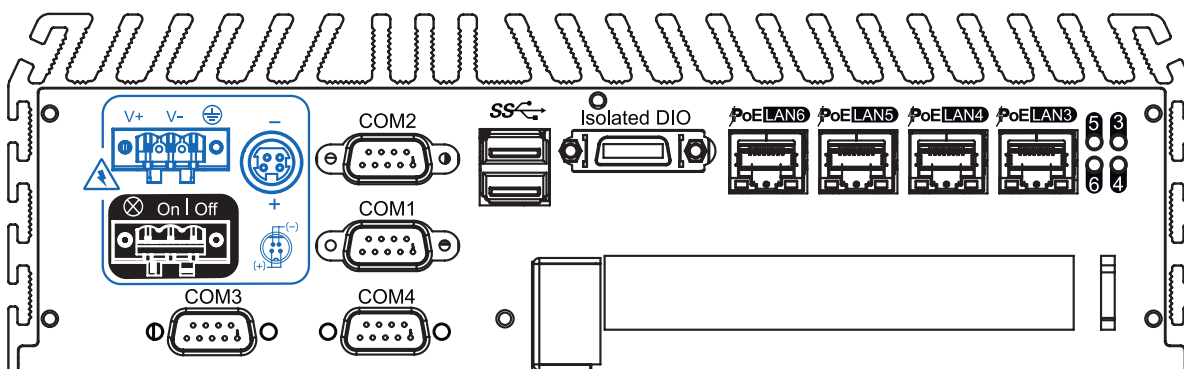

The ECS-7700/7100 series offers 6 to 36 VDC power input with the terminal block. If the power is supplied properly, the Power LED will light up a solid green.

80V power surge protection is design in in LTC4356. Grounding and write routing help limit the effects of noise due to EMI. Run the ground connection from the ground screw to the grounding surface prior to connecting the power.

See the figure shown below for the location of the earth ground on the terminal block power connector. Connect the earth ground wire to an appropriate grounded metal surface.

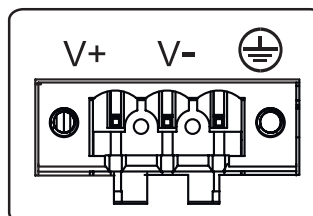

### 2.3.2 Remote Power On/Off Switch

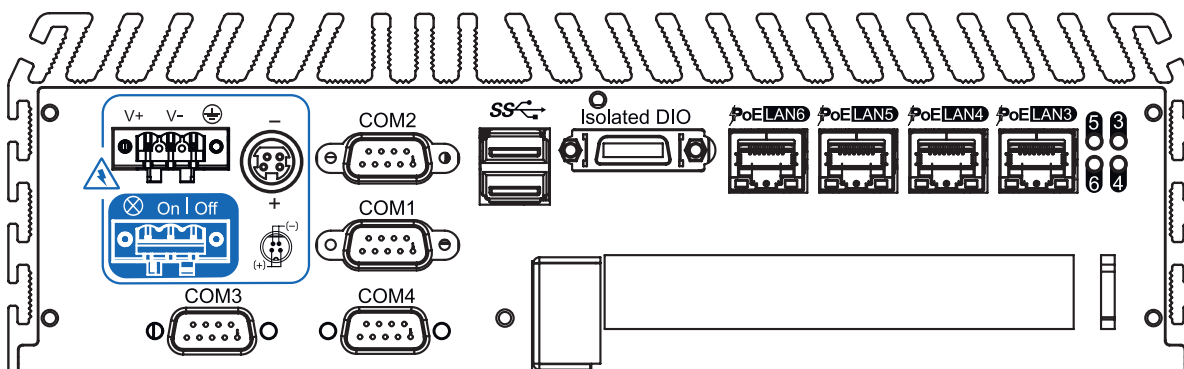

It is a 2-pin power-on or power-off switch through Phoenix Contact terminal block. You could turn on or off the system power by using this contact. This terminal block support dual function of soft power-on / power-off (instant off or delay 4 second), and suspend mode.

### 2.3.3 Serial Port COM2

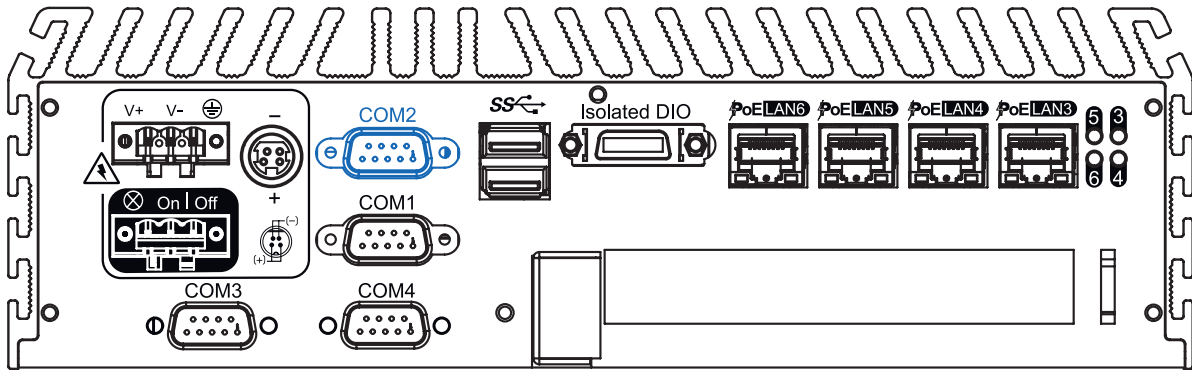

Serial port 2 can be configured for RS-232, RS-422, or RS-485 with auto flow control communication. Serial Port 2 default setting is RS-232, if you want to use RS-422 or RS-485, you can find the setting in BIOS.

BIOS Setting	Function
COM2	RS-232
	RS-422 (5-wire)
	RS-422 (9-wire)
	RS-485
	RS-485 w/z auto-flow control

The pin assignments are shown in the following table:

Serial Port	Pin No.	RS-232	RS-422 (5-Wire)	RS-422 (9-Wire)	RS-485 (3-Wire)
2	1	DCD	TXD-	TXD-	DATA-
	2	RXD	TXD+	TXD+	DATA+
	3	TXD	RXD+	RXD+	-----
	4	DTR	RXD-	RXD-	-----
	5	GND	GND	GND	GND
	6	DSR	-----	RTS-	-----
	7	RTS	-----	RTS+	-----
	8	CTS	-----	CTS+	-----
	9	RI	-----	CTS-	-----

### 2.3.4 Serial Port COM1, COM3 & COM4

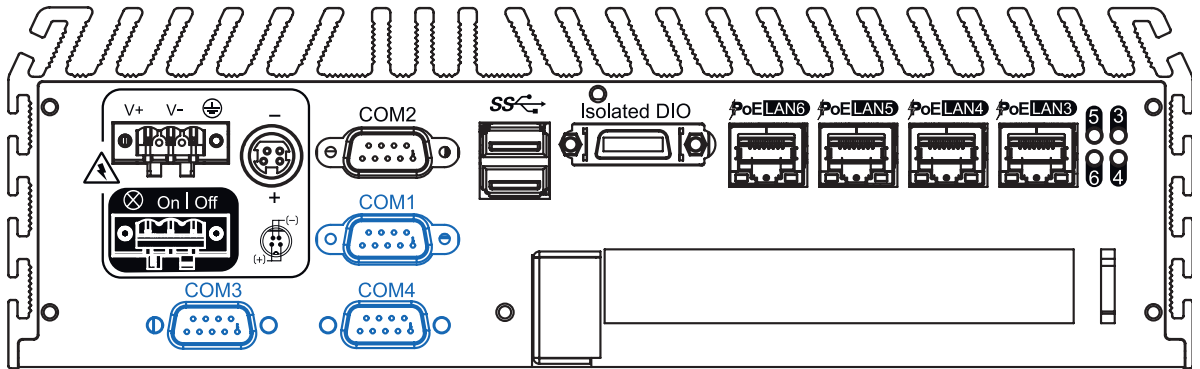

COM1, COM3 and COM4 are RS-232 only and provide up to 115200 bps baud rates. The pin assignments are shown in the following table:

BIOS Setting	Pin No.	Function
COM1, COM3, COM4	1	DCD
	2	RXD
	3	TXD
	4	DTR
	5	GND
	6	DSR
	7	RTS
	8	CTS
	9	RI



### 2.3.5 Isolated 8 DI / 8 DO

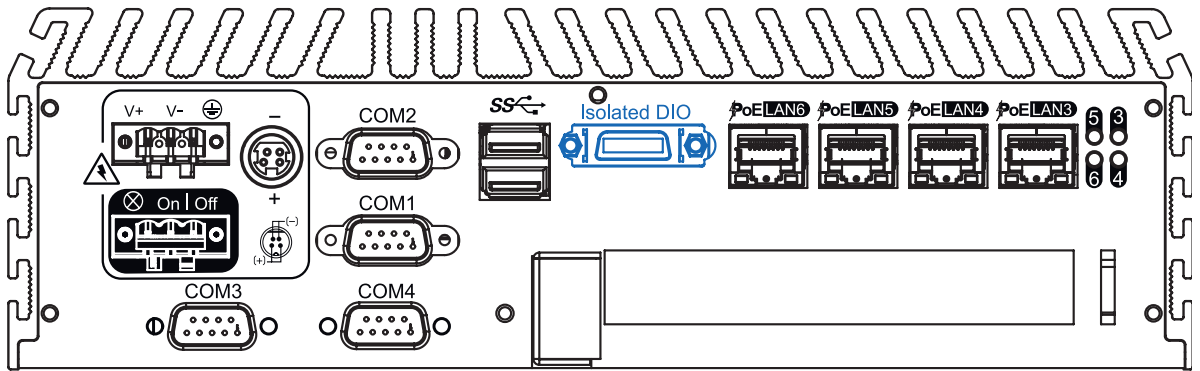

The ECS-7700 series offers an 16-bit DIO ( 8-DI / 8-DO) connector. Each bit of DI and DO equipped with a photo-coupler for isolated protection. A power buffer device TPD2007F integrated in 8-DO circuit for motors, solenoids, and lamp drivers applications.

Pin No.	Definition	Mapping to SIO GPIO Function
1	INPUT0	SIO_GPI50
2	INPUT 1	SIO_GPI51
3	INPUT 2	SIO_GPI52
4	INPUT 3	SIO_GPI53
5	INPUT 4	SIO_GPI54
6	INPUT 5	SIO_GPI55
7	INPUT 6	SIO_GPI56
8	INPUT 7	SIO_GPI57
9	DI_COM	
10	GND	
11	OUTPUT0	SIO_GPO20
12	OUTPUT 1	SIO_GPO21
13	OUTPUT 2	SIO_GPO22
14	OUTPUT 3	SIO_GPO23
15	OUTPUT 4	SIO_GPO24
16	OUTPUT 5	SIO_GPO25
17	OUTPUT 6	SIO_GPO26
18	OUTPUT 7	SIO_GPO27
19	N.C.	
20	External 24VDC Input	

### GPI SINK Mode

Isolated GPI input circuit in SINK mode (NPN) is illustrated as follows.

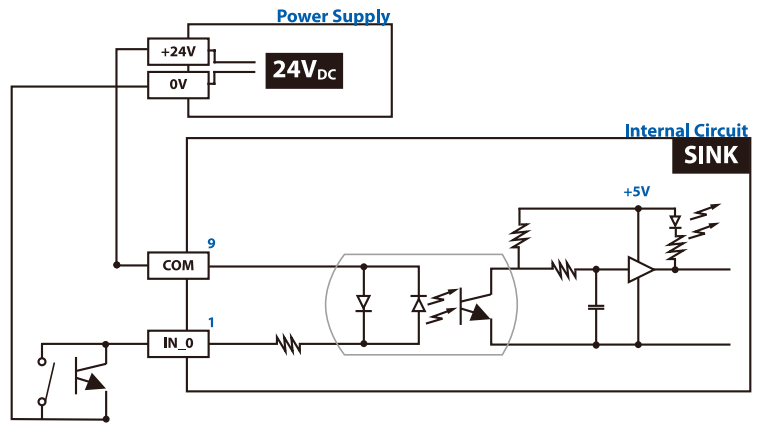

### GPI SOURCE Mode

Digital GPI input signal circuit in SOURCE mode (PNP) is illustrated as follow:

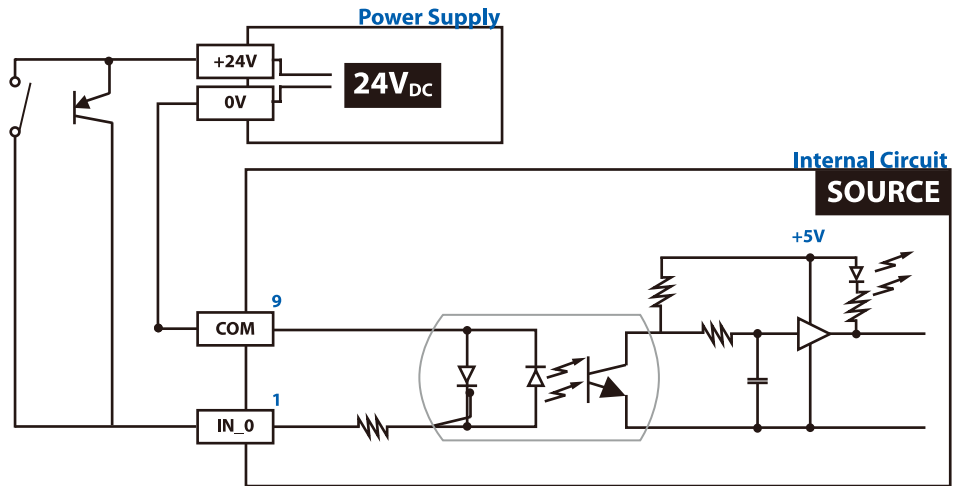

### GPO SINK Mode:

Digital GPO output circuit in SINK mode (NPN) is illustrated below.

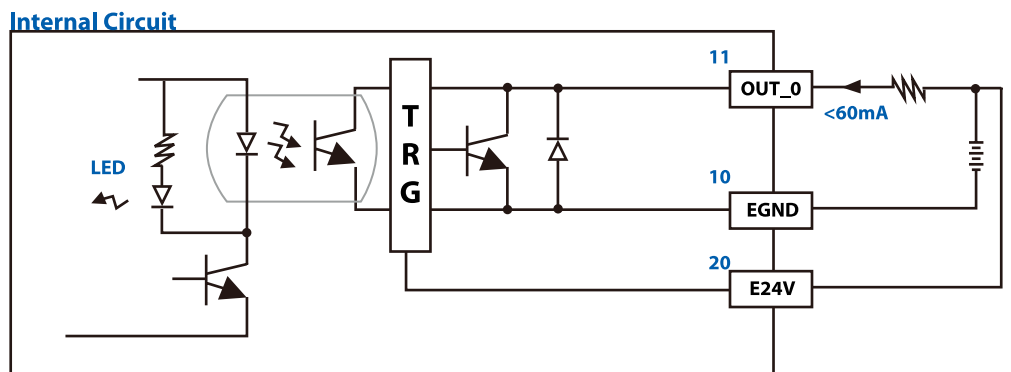

## 2.3.6 PoE, Power over Ethernet Ports

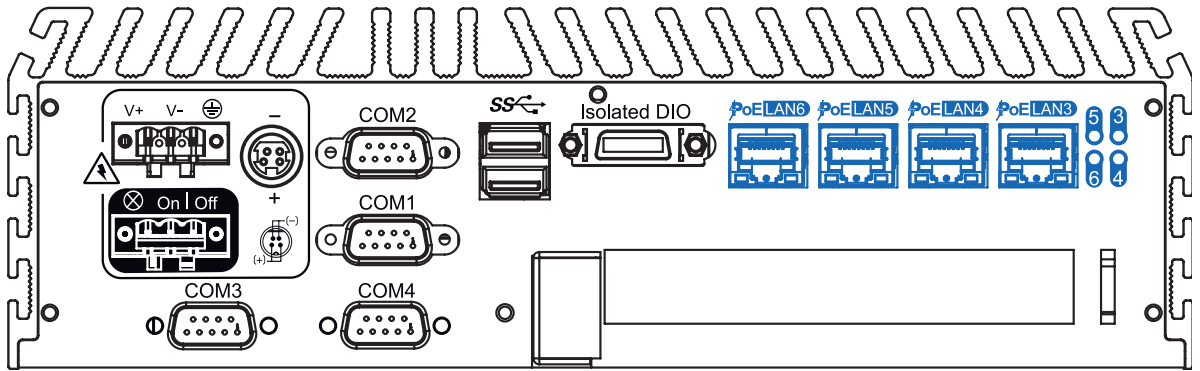

ECS-7700 series is equipped with 4 IEEE 802.3at PoE+ ports for transmitting power as much as 25.5W / 48V per port and 1000BASE-T gigabit data signals over standard Ethernet CAT-5/CAT-6 cable.

Every PoE port applies one Intel® 82574L Gigabit Ethernet controller and independent PCI express interface to connect with multi-core processor for network and data transmit optimization.

Only when PoE port starts to supply power to power devices , the dedicated LED will be light on.

# 2.4 Main Board Expansion Connectors

The figure below is the top view of the ECS-7700/7100 series main board. It shows the location of the connectors.

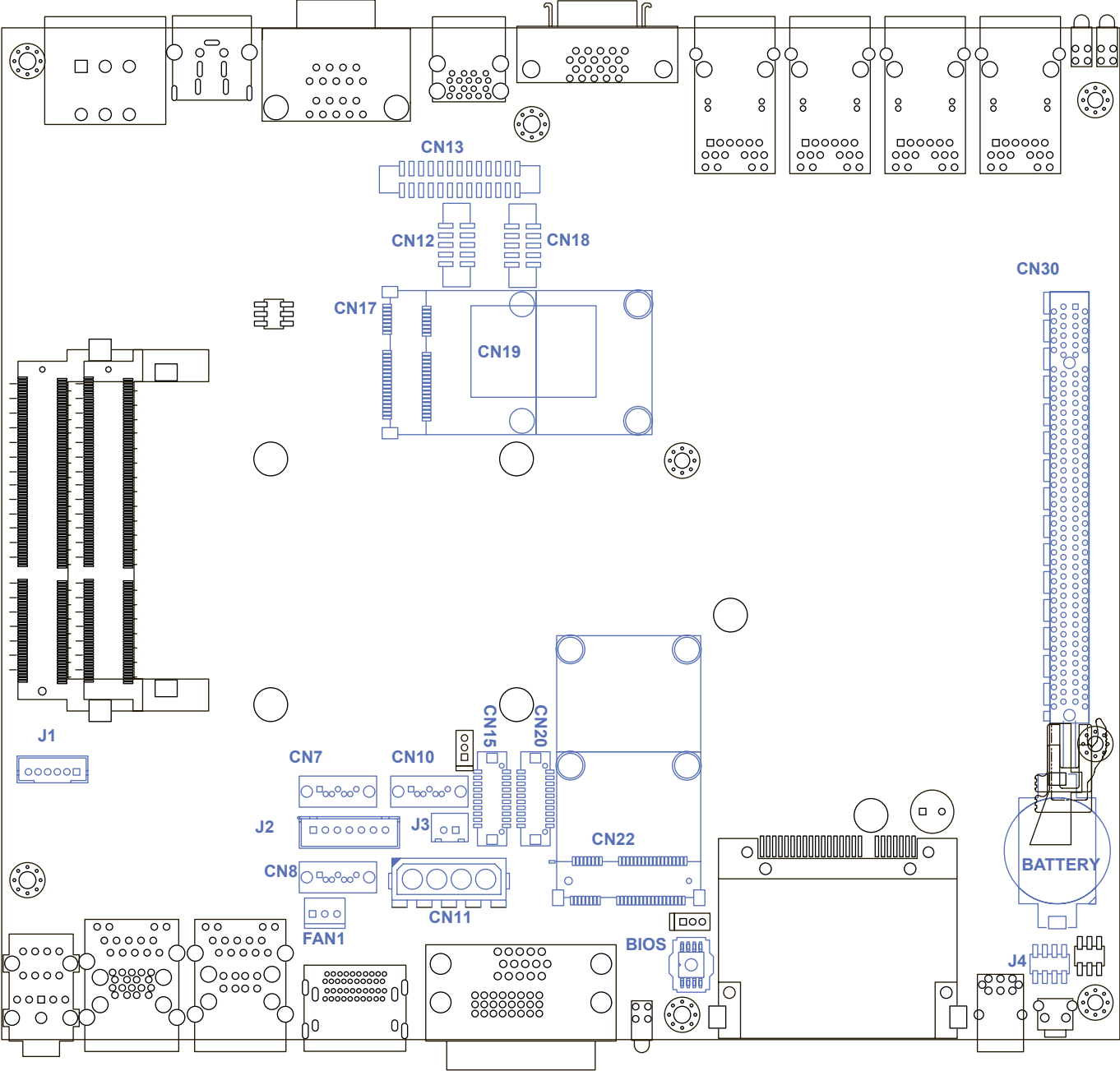
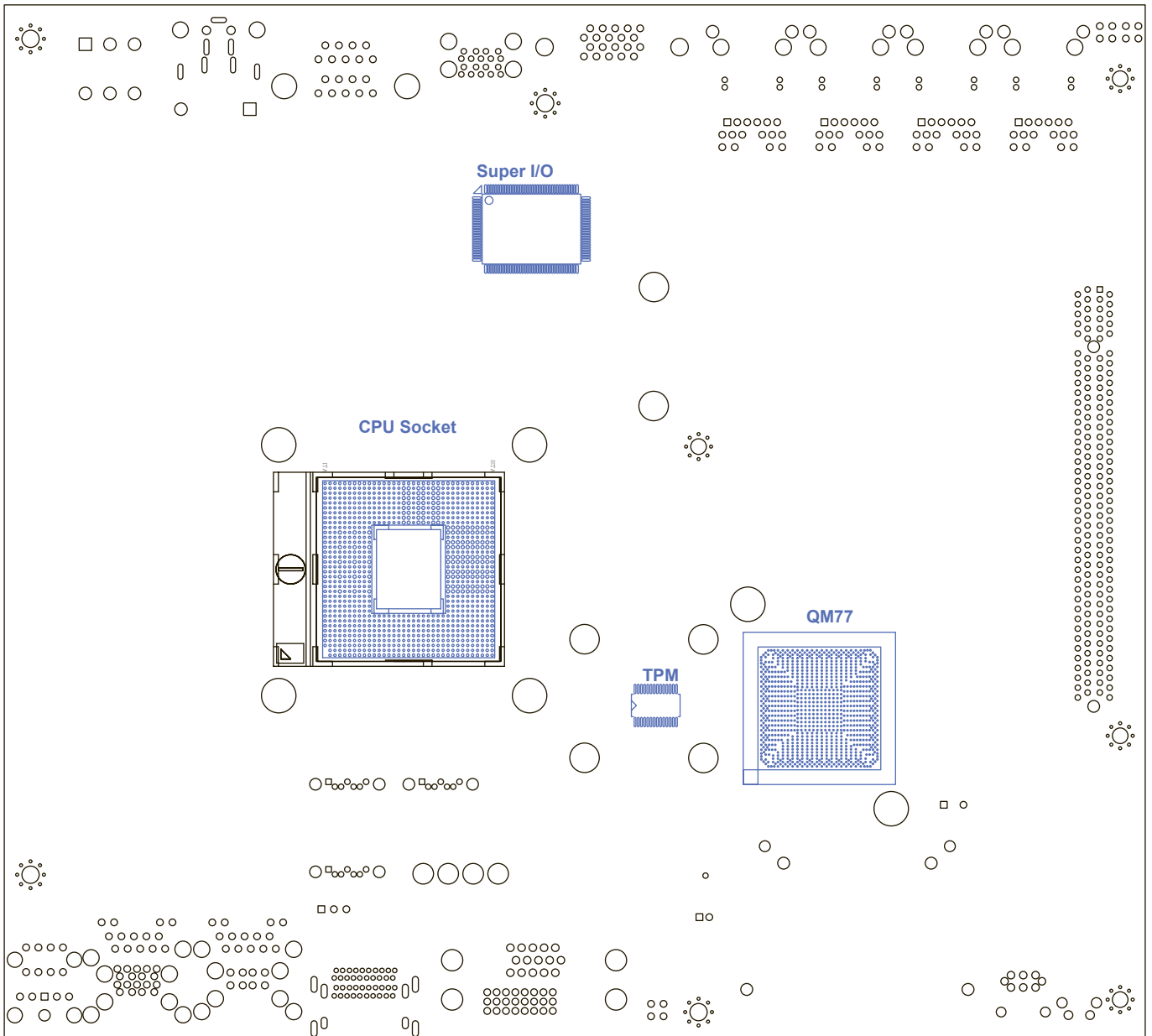
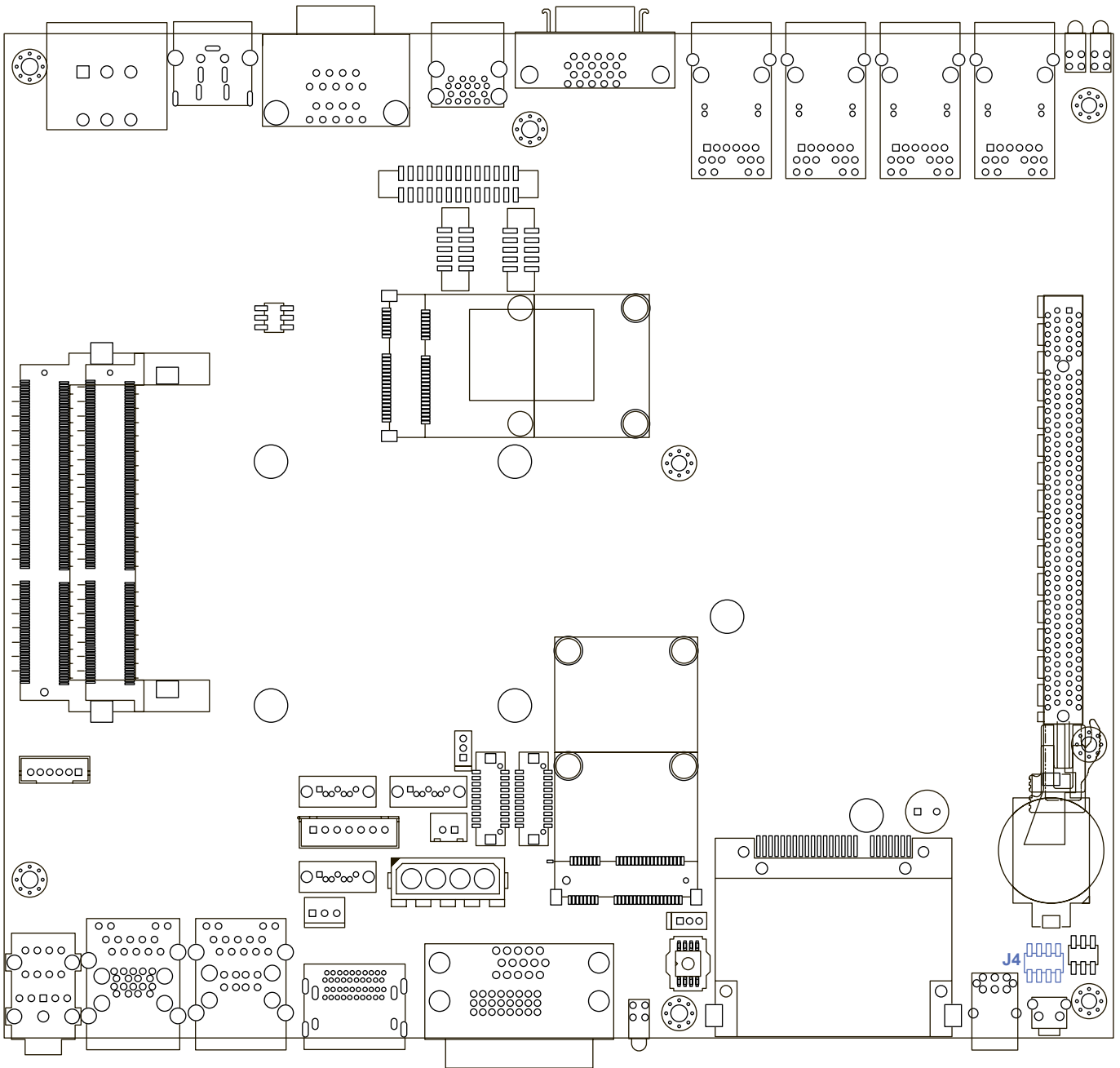

Figure 2.3.1 Internal Connectors and Jumpers

The figure below is the bottom view of the ECS-7700/7100 series main board.



## 2.4.1 J4 Miscellaneous Pin Header



These pin headers can be used as a backup for the following functions: hard drive LED indicator, reset button, power LED indicator, and power-on/off button. The front and top panel already provides access to these functions. The following table shows the pinouts for Miscellaneous port:

### J4 Miscellaneous Pin Header

Group	Pin No.	Description
HDD LED	1	HDLED
	3	HD_LED_N
Reset Button	5	FP_RST_BTN_N
	7	GND
Power LED	2	PWRLED
	4	PWROK_100MS_N
Power Button	6	FP_PWR_BTN_N
	8	GND

## 2.4.2 CN15, CN20, J2 LVDS

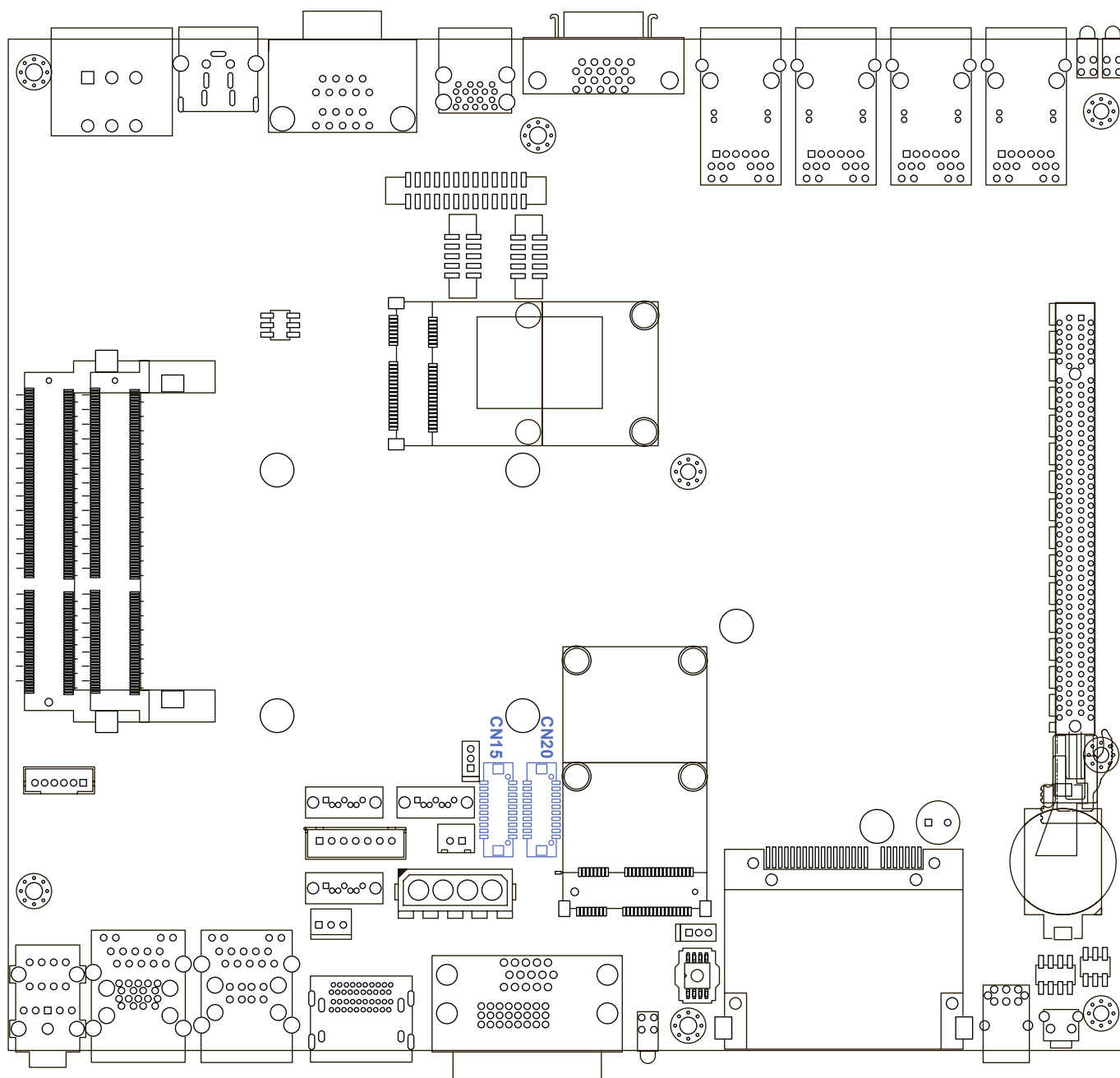

The ECS-7700/7100 series supports dual-channel 24-bit LVDS panel up to 1366x768 pixels resolution.

Pin No.	Definition	
	CN15 Channel A	CN20 Channel B
1	LDDC_CLK	LDDC_CLK
2	LDDC_DATA	LDDC_DATA
3	PANEL_VDD (+3.3V or +5V by jumper)	PANEL_VDD (+3.3V or +5V by jumper)
4	LA_DATA0_P	LB_DATA0_P
5	LA_DATA3_P	LB_DATA3_P
6	LA_DATA0_N	LB_DATA0_N
7	LA_DATA3_N	LB_DATA3_N
8	PANEL_VDD (+3.3V or +5V by jumper)	PANEL_VDD (+3.3V or +5V by jumper)
9	GND	GND

Pin No.	Definition	
	CN15 Channel A	CN20 Channel B
10	LA_DATA1_P	LB_DATA1_P
11	LA_CLKP	LB_CLKP
12	LA_DATA1_N	LB_DATA1_N
13	LA_CLKN	LB_CLKN
14	GND	GND
15	GND	GND
16	PANEL_BACKLIGHT (+12V)	PANEL_BACKLIGHT (+12V)
17	LA_DATA2_P	LB_DATA2_P
18	PANEL_BACKLIGHT (+12V)	PANEL_BACKLIGHT (+12V)
19	LA_DATA2_N	LB_DATA2_N
20	GND	GND

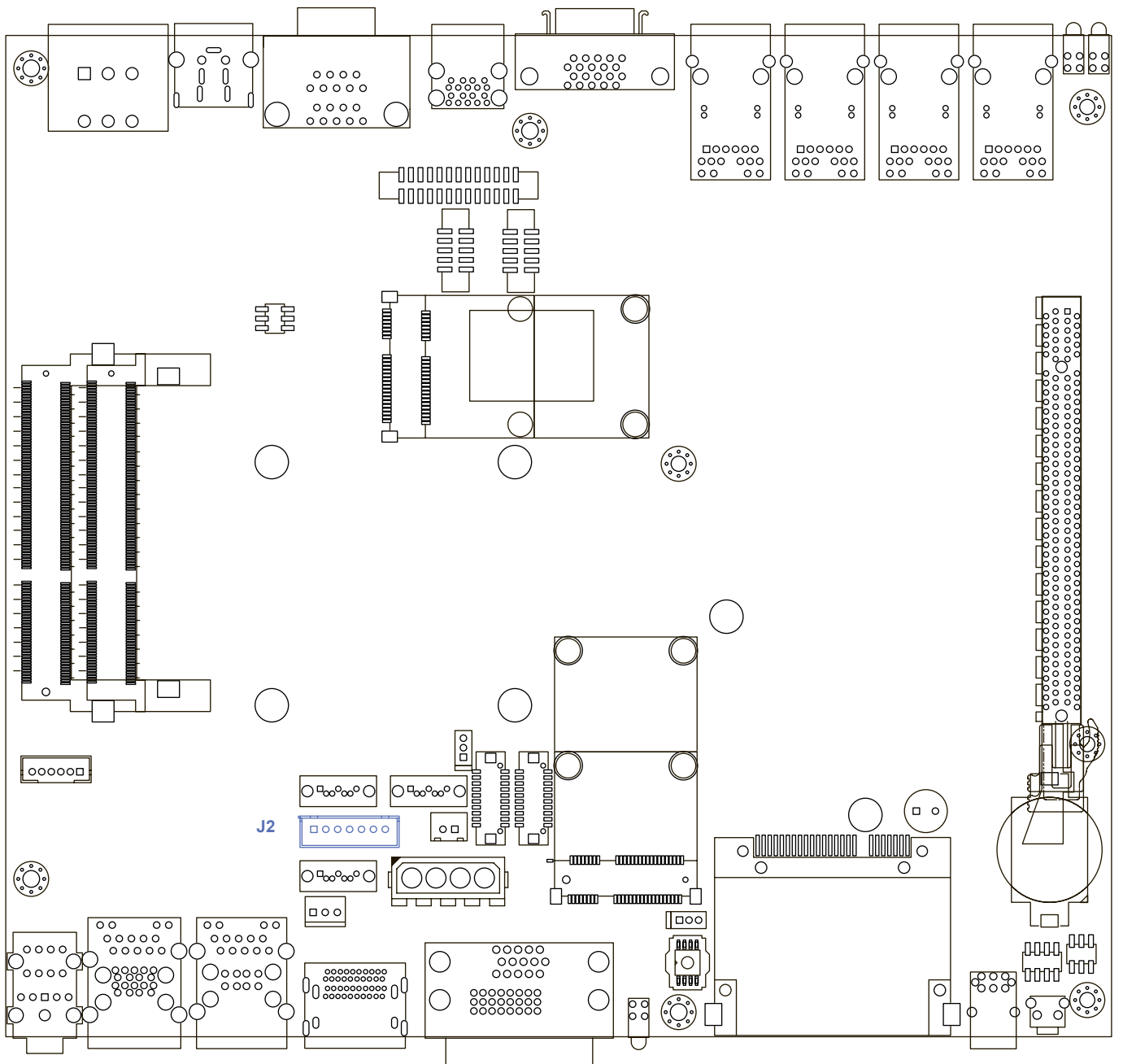



The LCD inverter is connected to J2 via a JST 7-pin, 2.5mm connector to provide +5V/+12V power to the LCD display.

Pin No.	Definition
1	+5V
2	+12V
3	+12V
4	LBKLT_CTL
5	GND
6	GND
7	LBKLT_EN

### 2.4.3 CN7, CN8 SATA3 & CN11 SATA Power Connector

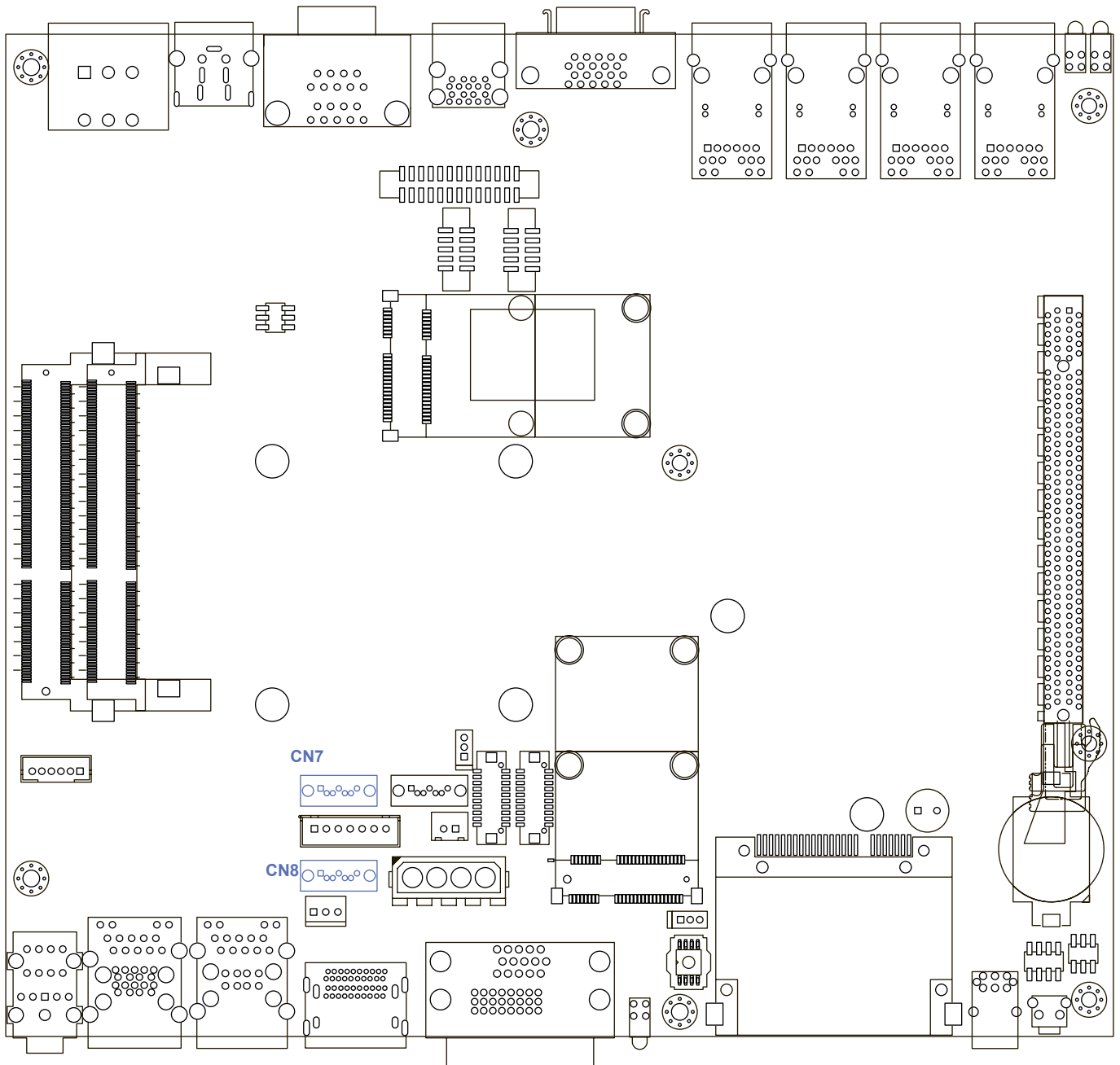

The ECS-7700/7100 series features 2 high performance Serial ATA III interfaces that ease cabling to hard drives or SSD with thin and short cables while application need larger storage capacity.

Pin No.	Definition
1	GND
2	TXP
3	TXN
4	GND
5	RXN
6	RXP
7	GND

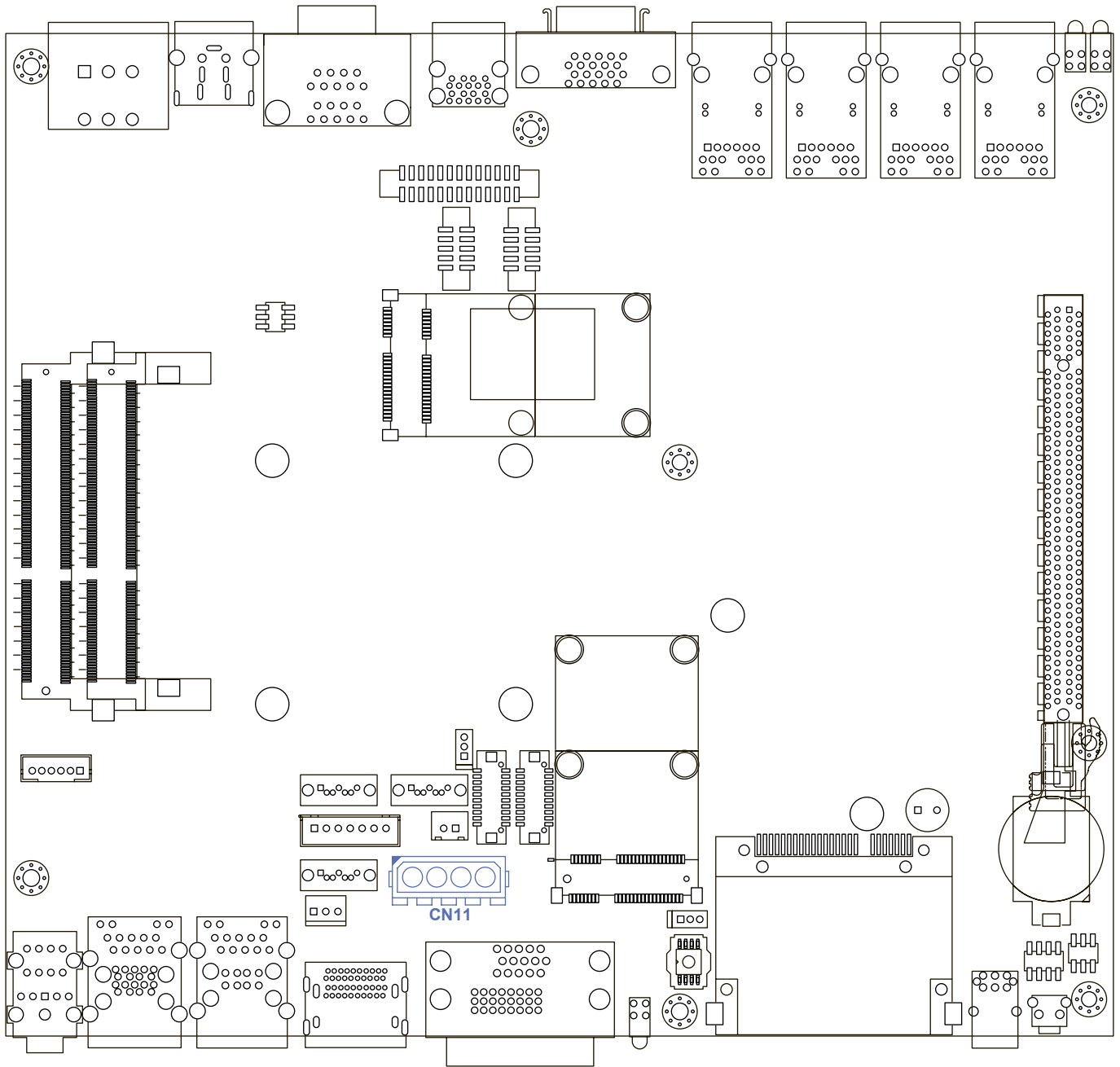

The ECS-7700/7100 series is also equipped one SATA power connector. It supplies 5V (2A max.) and 12V (1A max) current to the hard drive or SSD.

#### CN11 SATA HDD Power Connections

Pin No.	Definition
1	+12V
2	GND
3	GND
4	+5V

## 2.4.4 CN10 SATA-II Connector J3 SATA DOM Power Connector

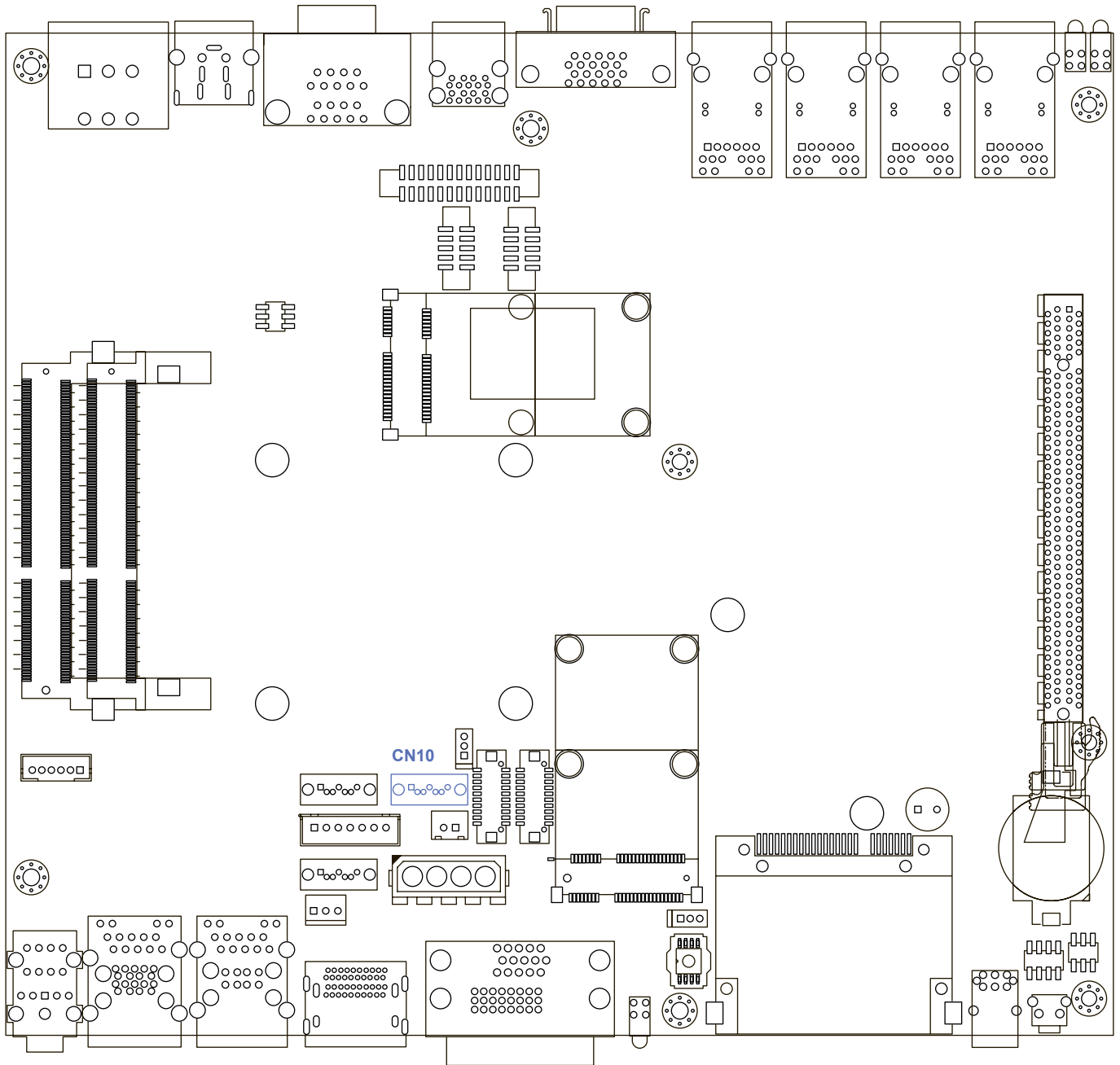

The ECS-7700/7100 series features one SATA-II interface while applications need SATA DOM.

Pin No.	Definition
1	GND
2	TXP
3	TXN
4	GND
5	RXN
6	RXP
7	GND

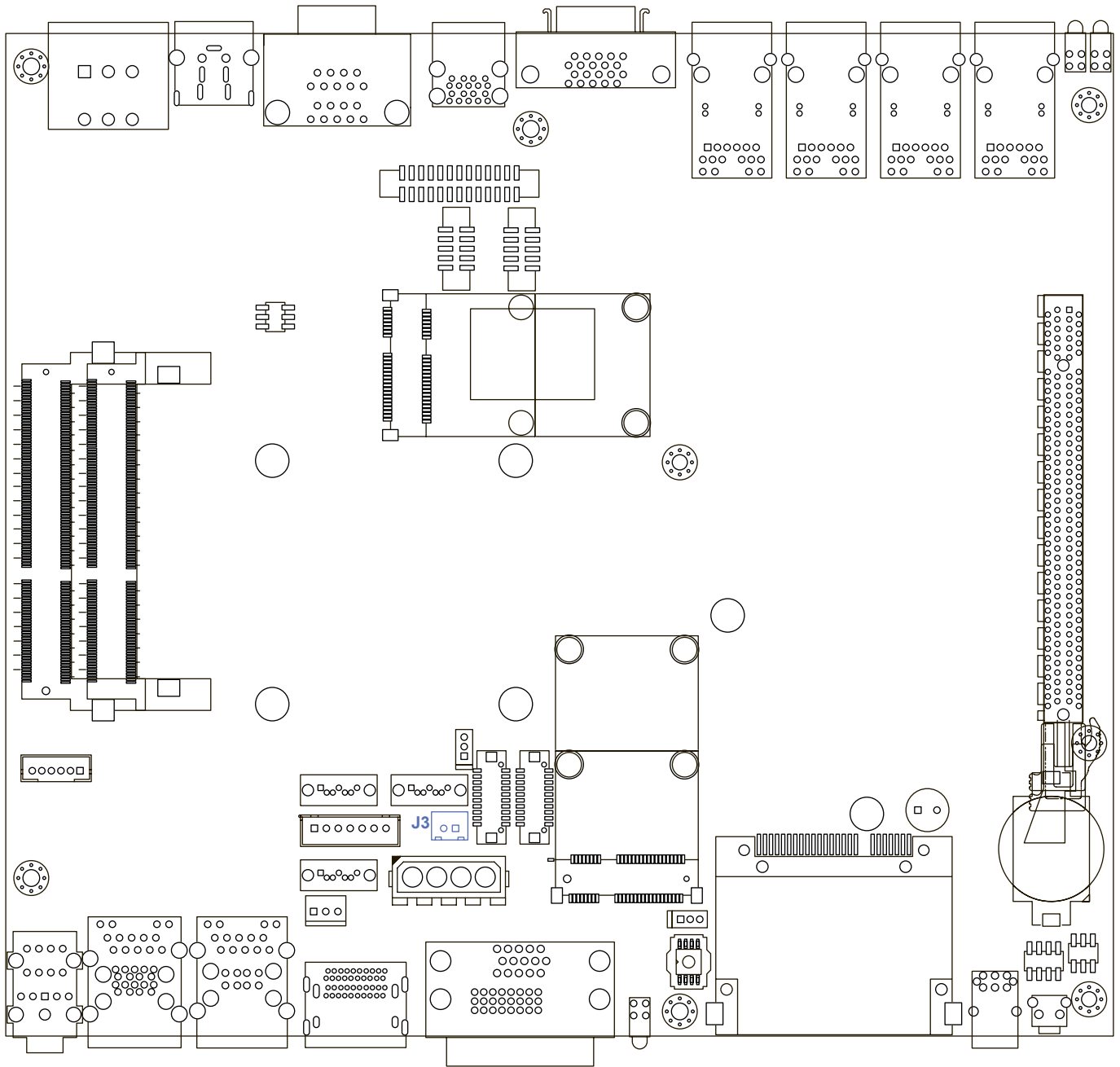

The ECS-7700/7100 series is also equipped one SATA DOM power connector. It supplies 5V (0.5A max.) current to the SATA DOM.

### J3 SATA DOM Power Connections

Pin No.	Definition
1	+5V
2	GND

## 2.4.5 J1 Internal USB Dual Port

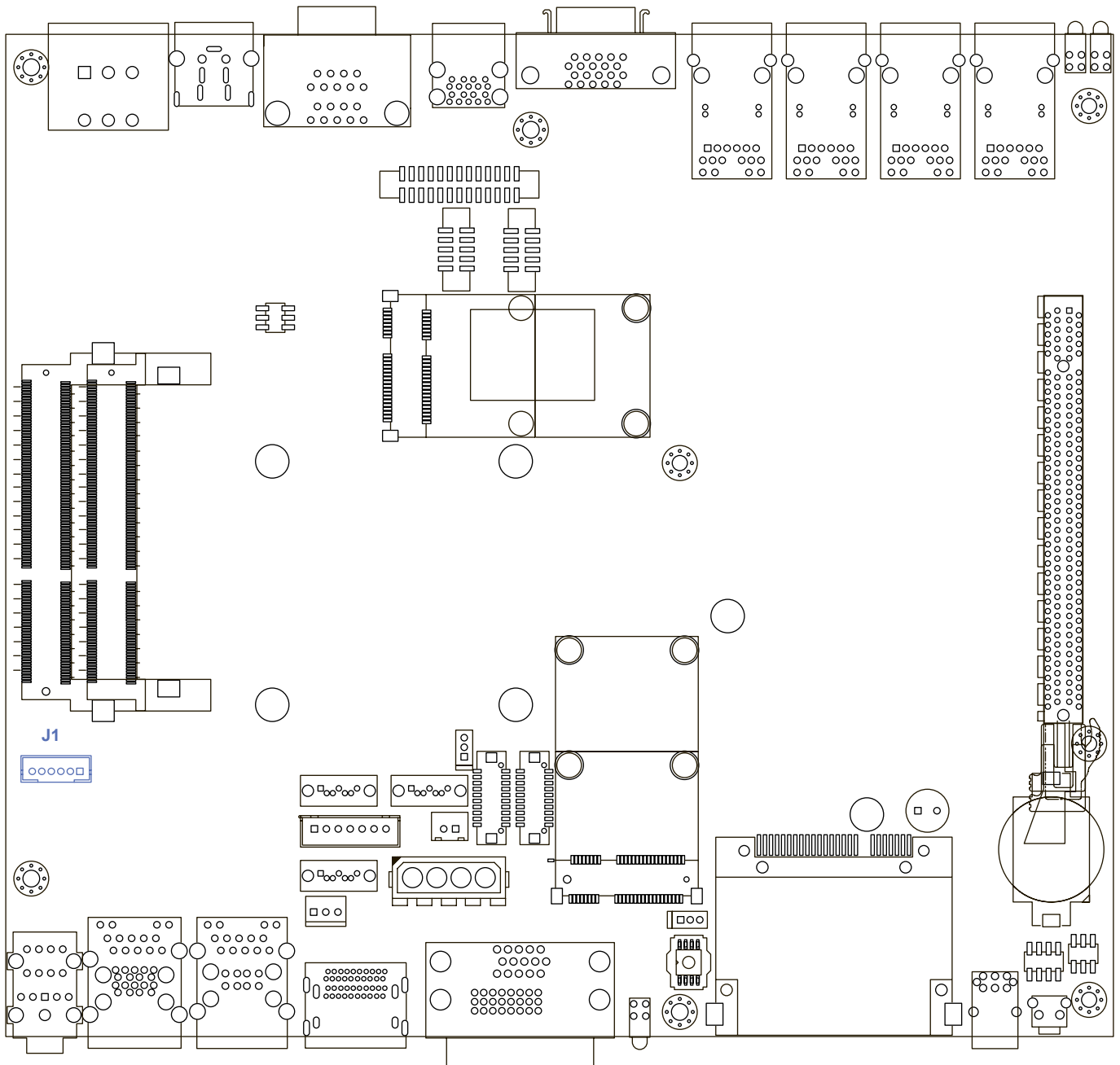

The ECS-7700/7100 series' main board provides up to two USB plug-and-play ports for Dongle Key or LCD touch Panel using. The USB interface supports 480 Mbps transfer rate which complies with high speed USB specification Rev. 2.0, and fuse protection. The USB interface is accessed through one 1x6-pin JST 2.0mm connector. You will need an adapter cable if you use a standard USB connector. The adapter cable has a 1x6-pin connector on one end and a USB connector on the other.

Pin No.	Definition	Pin No.	Definition
1	USB_VCC	2	USBD2-
3	USBD2+	4	USBD3-
5	USBD3+	6	GND

## 2.4.6 CN17, CN22 Mini-PCIe, mSATA Connectors

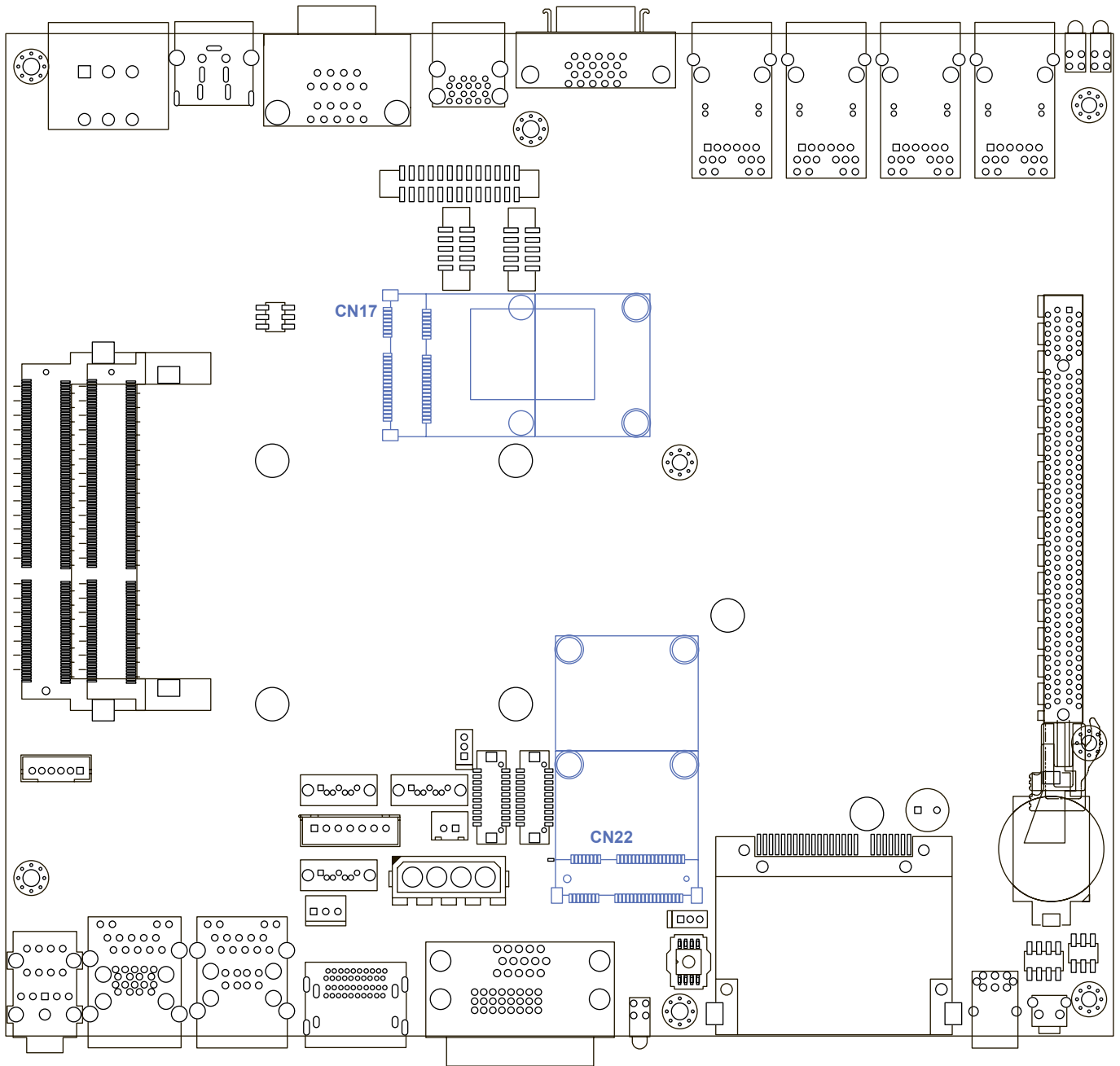

Both mSATA and Mini PCI-E share the same form-factor and similar electrical pinout assignments on their connectors. There was no clear mechanism to distinguish if a mSATA drive or a Mini PCI-E device is plugged into the socket until recently that SATA-IO issued an ECN change (ECN #045) to re-define pin 43 on mSATA connector as “no connect” instead of “return current path” ( or GND).

When an mSATA drive is inserted, its pin 43 is “no connect”, and the respective pin on the socket is being pulled-up to logic 1. When a Mini PCI-E device is inserted, its pin 43 forces the respective pin on the socket to ground, or logic 0.

ECS-7700/7100 series is using Pin 43 status designed for switching between mSATA drive and mini PCI-e device.

Status	Mini PCI-e card	mSATA drive
Pin 43	Logic 0	Logic 1

### CN22 Mini-PCIe Connector Pin Out

Pin No.	Signal Name	Pin No.	Signal Name	Pin No.	Signal Name	Pin No.	Signal Name
51	Reserved	52	+3.3Vaux	33	PETp0	34	GND
49	Reserved	50	GND	31	PETn0	32	SMB_DATA
47	Reserved	48	+1.5V	29	GND	30	SMB_CLK
45	Reserved	46	Reserved	27	GND	28	+1.5V
43	Status	44	Reserved	25	PERp0	26	GND
41	+3.3Vaux	42	Reserved	23	PERn0	24	+3.3Vaux
39	+3.3Vaux	40	GND	21	GND	22	PERST#
37	GND	38	USB_D+	19	Reserved	20	reserved
35	GND	36	USB_D-	17	Reserved	18	GND
Mechanical Key							
15	GND	16	Reserved	7	CLKREQ#	8	Reserved
13	REFCLK+	14	Reserved	5	Reserved	6	1.5V
11	REFCLK-	12	Reserved	3	Reserved	4	GND
9	GND	10	Reserved	1	WAKE#	2	3.3Vaux

### CN17 Mini-PCIe Connector Pin Out

Pin No.	Signal Name	Pin No.	Signal Name	Pin No.	Signal Name	Pin No.	Signal Name
51	Reserved	52	+3.3Vaux	33	PETp0	34	GND
49	Reserved	50	GND	31	PETn0	32	SMB_DATA
47	Reserved	48	+1.5V	29	GND	30	SMB_CLK
45	Reserved	46	Reserved	27	GND	28	+1.5V
43	Status	44	Reserved	25	PERp0	26	GND
41	+3.3Vaux	42	Reserved	23	PERn0	24	+3.3Vaux
39	+3.3Vaux	40	GND	21	GND	22	PERST#
37	GND	38	USB_D+	19	Reserved	20	reserved
35	GND	36	USB_D-	17	Reserved	18	GND
Mechanical Key							
15	GND	16	UIM_VPP	7	CLKREQ#	8	UIM_PWR
13	REFCLK+	14	UIM_RST	5	Reserved	6	1.5V
11	REFCLK-	12	UIM_CLK	3	Reserved	4	GND
9	GND	10	UIM_DATA	1	WAKE#	2	3.3Vaux



## 2.4.7 CN13 GPIO

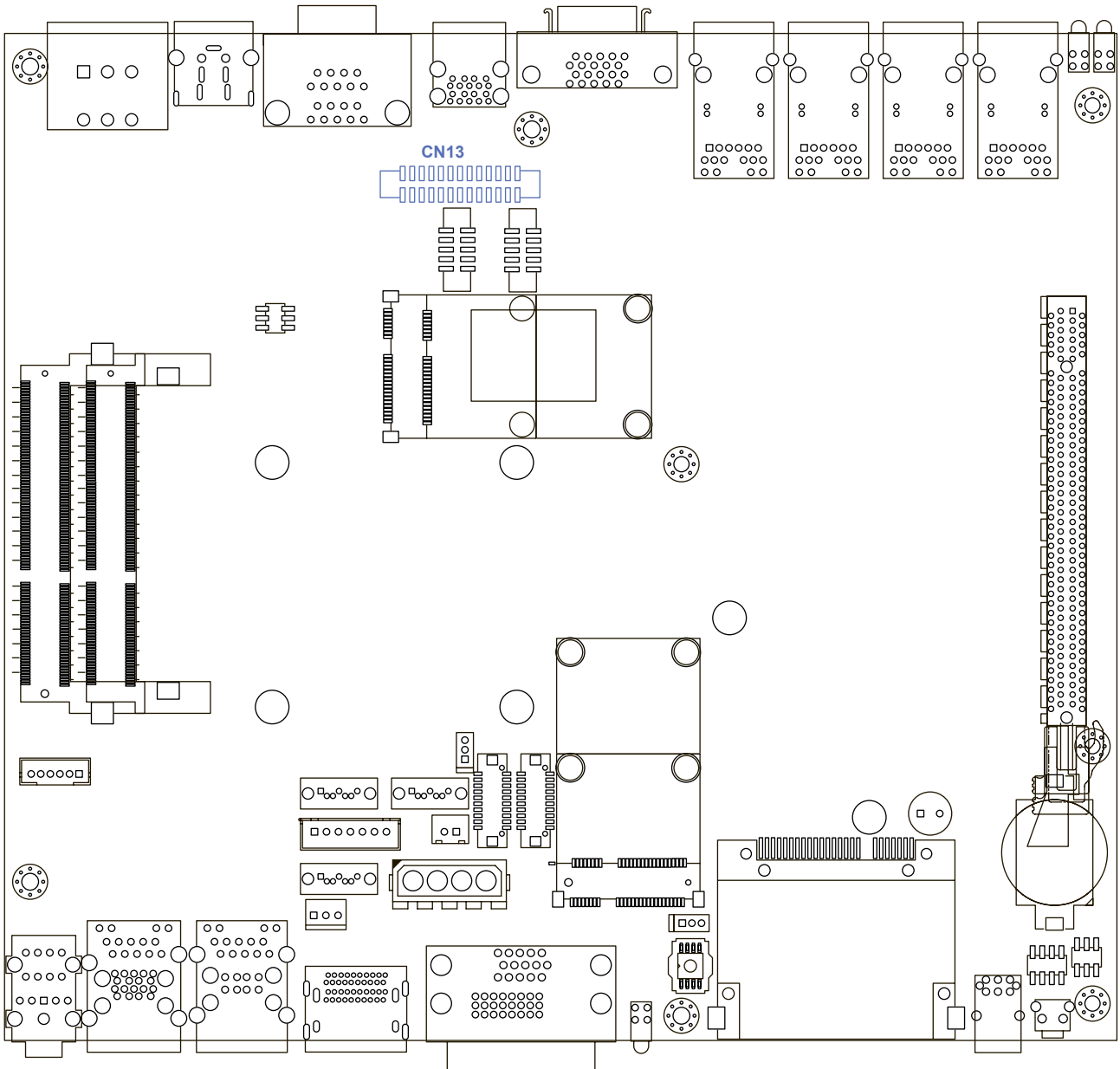

The ECS-7700/7100 series offers 16 programmable I/O within TTL 5V tolerance. If the GPIO is logic high, it indicates that the mapping SIO GPIO pin is logic high level. If the GPIO is logic low, it indicates that the mapping SIO GPIO pin is logic low level.

Pin No.	Description	Pin No.	Description
1	GND	14	GND
2	SIO_GP17	15	SIO_GP67
3	SIO_GP16	16	SIO_GP66
4	SIO_GP15	17	SIO_GP65
5	SIO_GP14	18	SIO_GP64
6	GND	19	GND
7	SIO_GP13	20	SIO_GP63
8	SIO_GP12	21	SIO_GP62
9	SIO_GP11	22	SIO_GP61
10	SIO_GP10	23	SIO_GP60
11	GND	24	GND
12	SMB_DATA	25	+5V
13	SMB_CLK	26	+5V

## 2.4.8 FAN1

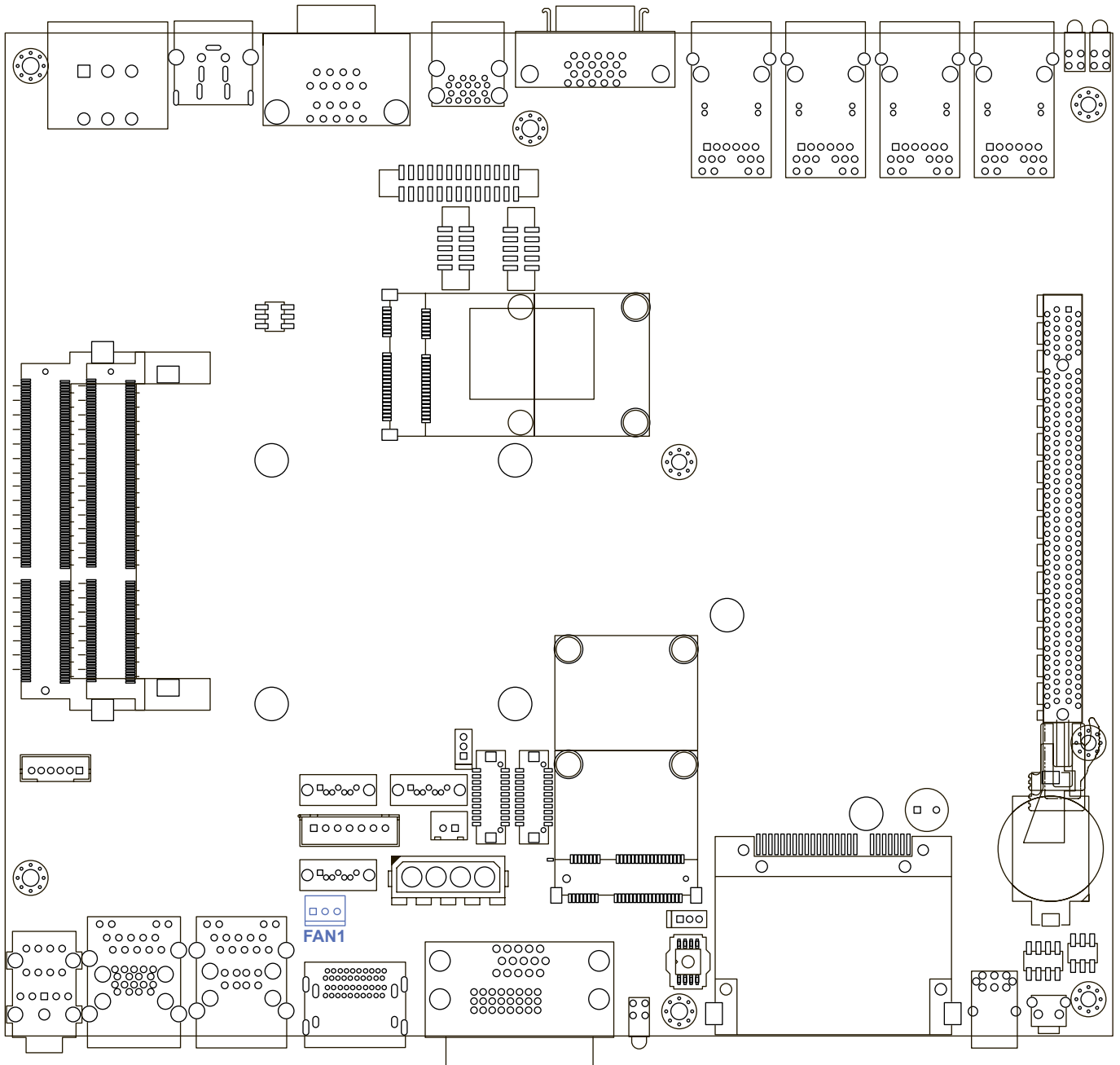

FAN power connector supports for higher thermal requirement.

Pin Out	Function
1	GND
2	+12V (1.5A max)
3	Fan-speed sense

## 2.4.9 CN30 PCIe x16

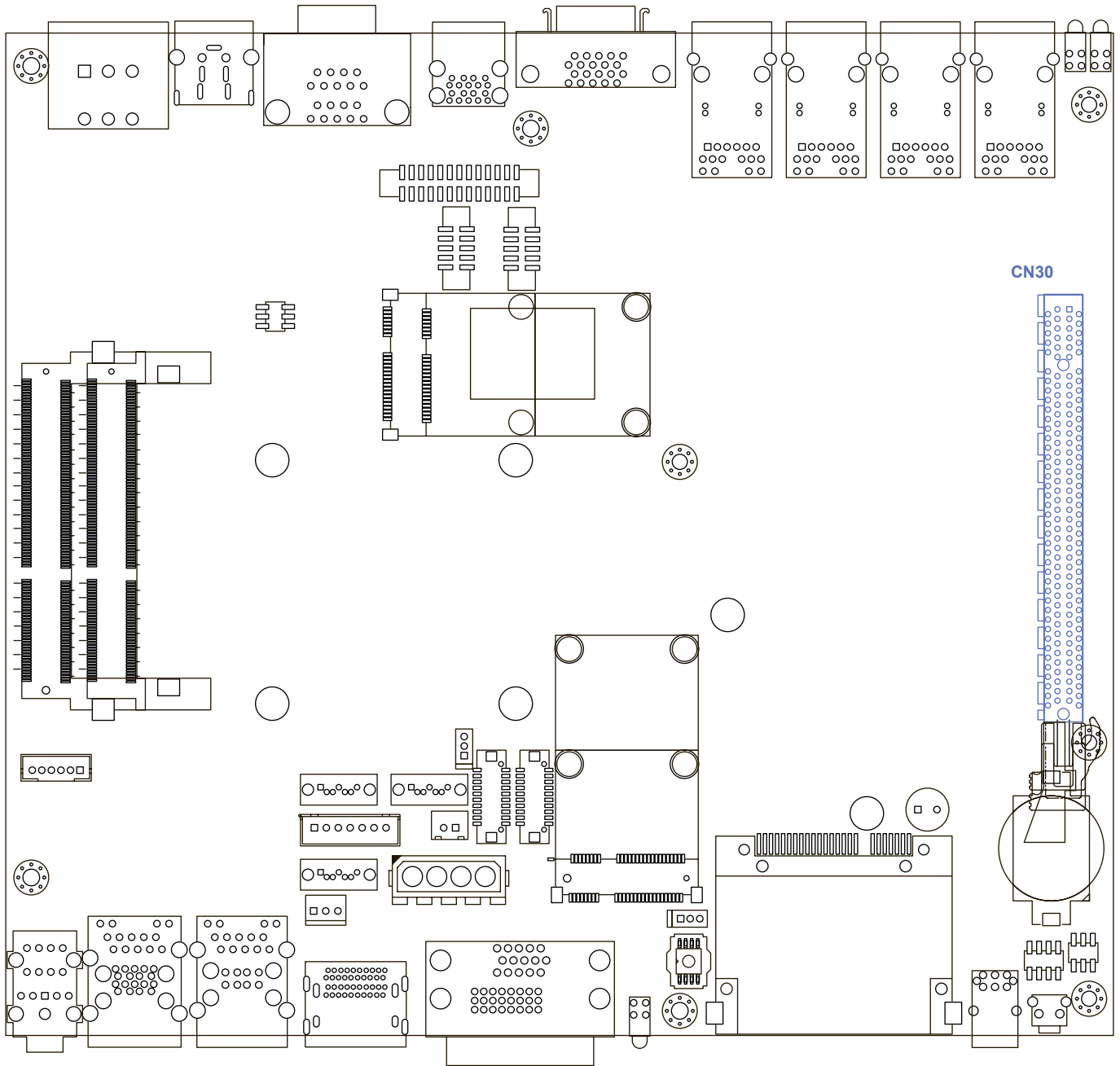

CN30 Pin out

Pin Out	Function	Pin Out	Function	Pin Out	Function	Pin Out	Function
A1	Reserved	A2	+12V	A43	PEG_RX6P	A44	PEG_RX6N
A3	+12V	A4	GND	A45	GND	A46	GND
A5	CLK_PEGC_P	A6	CLK_PEGC_N	A47	PEG_RX7P	A48	PEG_RX7N
A7	Reserved	A8	CLKREQ_PEGA#	A49	GND	A50	Reserved
A9	+3.3V	A10	+3.3V	A51	GND	A52	PEG_RX8P
A11	PLTRST_SUMIT#	A12	GND	A53	PEG_RX8N	A54	GND
A13	CLK_PEGA_P	A14	CLK_PEGA_N	A55	GND	A56	PEG_RX9P
A15	GND	A16	PEG_RX0P	A57	PEG_RX9N	A58	GND
A17	PEG_RX0N	A18	GND	A59	GND	A60	PEG_RX10P

Pin Out	Function	Pin Out	Function	Pin Out	Function	Pin Out	Function
A19	CLKREQ_PEGB#	A20	GND	A61	PEG_RX10N	A62	GND
A21	PEG_RX1P	A22	PEG_RX1N	A63	GND	A64	PEG_RX11P
A23	GND	A24	GND	A65	PEG_RX11N	A66	GND
A25	PEG_RX2P	A26	PEG_RX2N	A67	GND	A68	PEG_RX12P
A27	GND	A28	GND	A69	PEG_RX12N	A70	GND
A29	PEG_RX3P	A30	PEG_RX3N	A71	GND	A72	PEG_RX13P
A31	GND	A32	CLK_PEGB_P	A73	PEG_RX13N	A74	GND
A33	CLK_PEGB_N	A34	GND	A75	GND	A76	PEG_RX14P
A35	PEG_RX4P	A36	PEG_RX4N	A77	PEG_RX14N	A78	GND
A37	GND	A38	GND	A79	GND	A80	PEG_RX15P
A39	PEG_RX5P	A40	PEG_RX5N	A81	PEG_RX15N	A82	GND
A41	GND	A42	GND				

Pin Out	Function	Pin Out	Function	Pin Out	Function	Pin Out	Function
B1	+12V	B2	+12V	B41	PEG_TX6P	B42	PEG_TX6N
B3	+12V	B4	GND	B43	GND	B44	GND
B5	SMB_CLK_MAIN	B6	SMB_DAT_MAIN	B45	PEG_TX7P	B46	PEG_TX7N
B7	GND	B8	+3.3V	B47	GND	B48	Reserved
B9	Reserved	B10	+3.3V_SB	B49	GND	B50	PEG_TX8P
B11	PCIE_WAKE#	B12	Reserved	B51	PEG_TX8N	B52	GND
B13	GND	B14	PEG_TX0P	B53	GND	B54	PEG_TX9P
B15	PEG_TX0N	B16	GND	B55	PEG_TX9N	B56	GND
B17	Reserved	B18	GND	B57	GND	B58	PEG_TX10P
B19	PEG_TX1P	B20	PEG_TX1N	B59	PEG_TX10N	B60	GND
B21	GND	B22	GND	B61	GND	B62	PEG_TX11P
B23	PEG_TX2P	B24	PEG_TX2N	B63	PEG_TX11N	B64	GND
B25	GND	B26	GND	B65	GND	B66	PEG_TX12P
B27	PEG_TX3P	B28	PEG_TX3N	B67	PEG_TX12N	B68	GND
B29	GND	B30	Reserved	B69	GND	B70	PEG_TX13P
B31	Reserved	B32	GND	B71	PEG_TX13N	B72	GND
B33	PEG_TX4P	B34	PEG_TX4N	B73	GND	B74	PEG_TX14P
B35	GND	B36	GND	B75	PEG_TX14N	B76	GND
B37	PEG_TX5P	B38	PEG_TX5N	B77	GND	B78	PEG_TX15P
B39	GND	B40	GND	B79	PEG_TX15N	B80	GND
				B81	Reserved	B82	Reserved

## 2.4.10 Battery

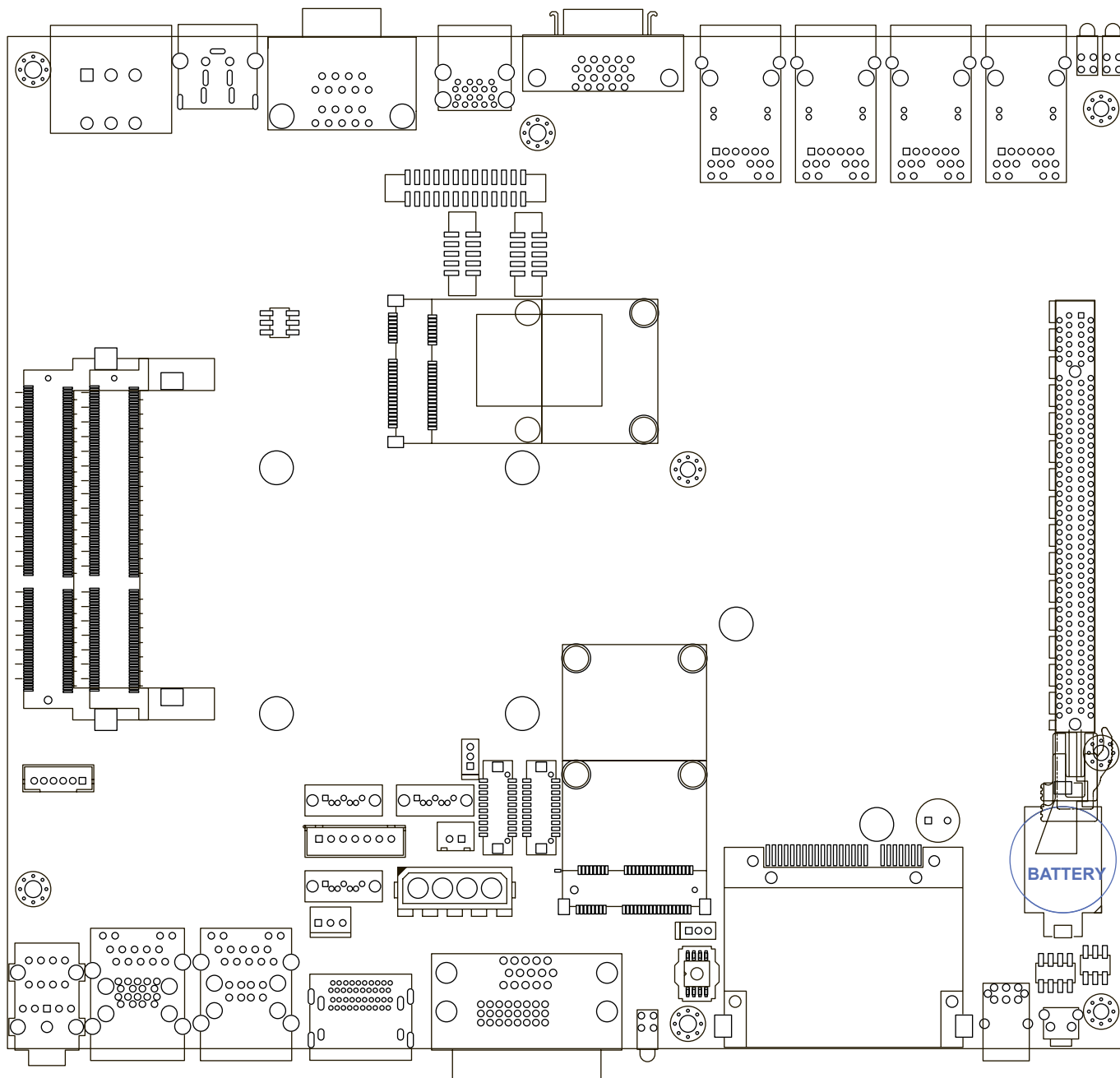

The ECS-7700/7100 series' real-time clock is powered by a lithium battery. The battery is Panasonic BR2032 190mAh lithium battery. Replacing the lithium battery on your own is **NOT** recommended. If the battery needs to be changed, please contact with the Vecow RMA service team.

# 2.5 Main Board Jumper Setting

The figure below is the top view of the ECS-7700/7100 series main board which is the main board used in the ECS-7700/7100 series system. It shows the location of the jumpers.

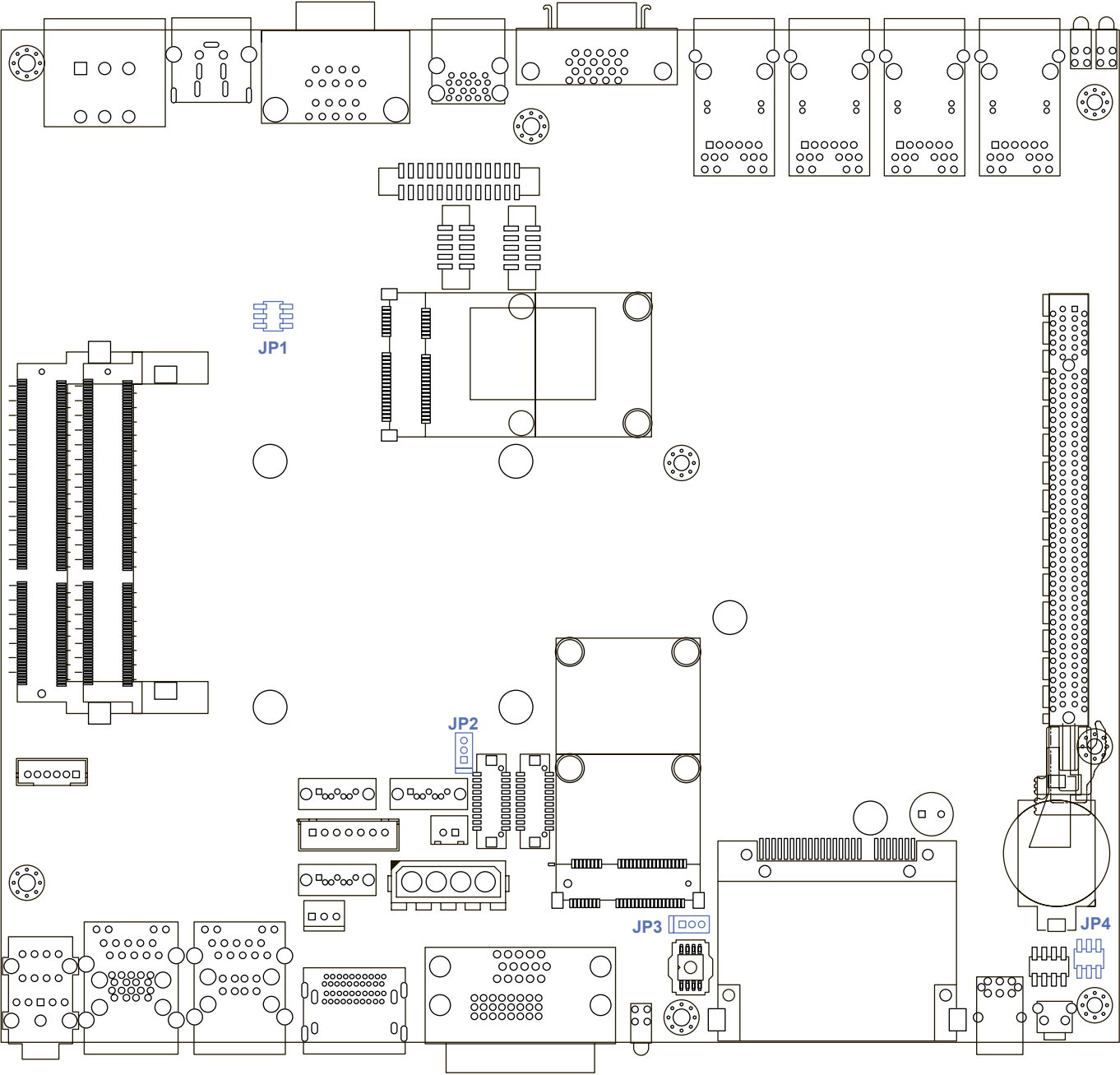

You may configure your card to match the needs of your application by setting jumpers. A jumper is a metal bridge used to close an electric circuit. It consists of two metal pins and a small metal clip (often protected by a plastic cover) that slides over the pins to connect them. To “close” a jumper, you connect the pins with the clip. To “open” a jumper, you remove the clip. Sometimes a jumper will have three pins, labeled 1, 2 and 3. In this

case you would connect either pins 1 and 2, or 2 and 3.

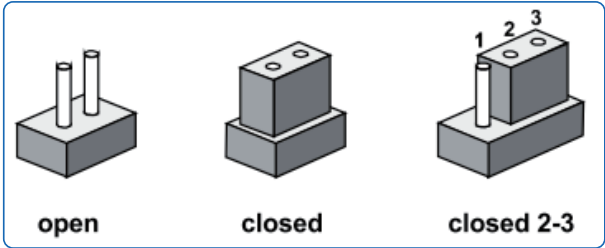

## 2.5.1 JP2 LVDS Backlight Power Selection

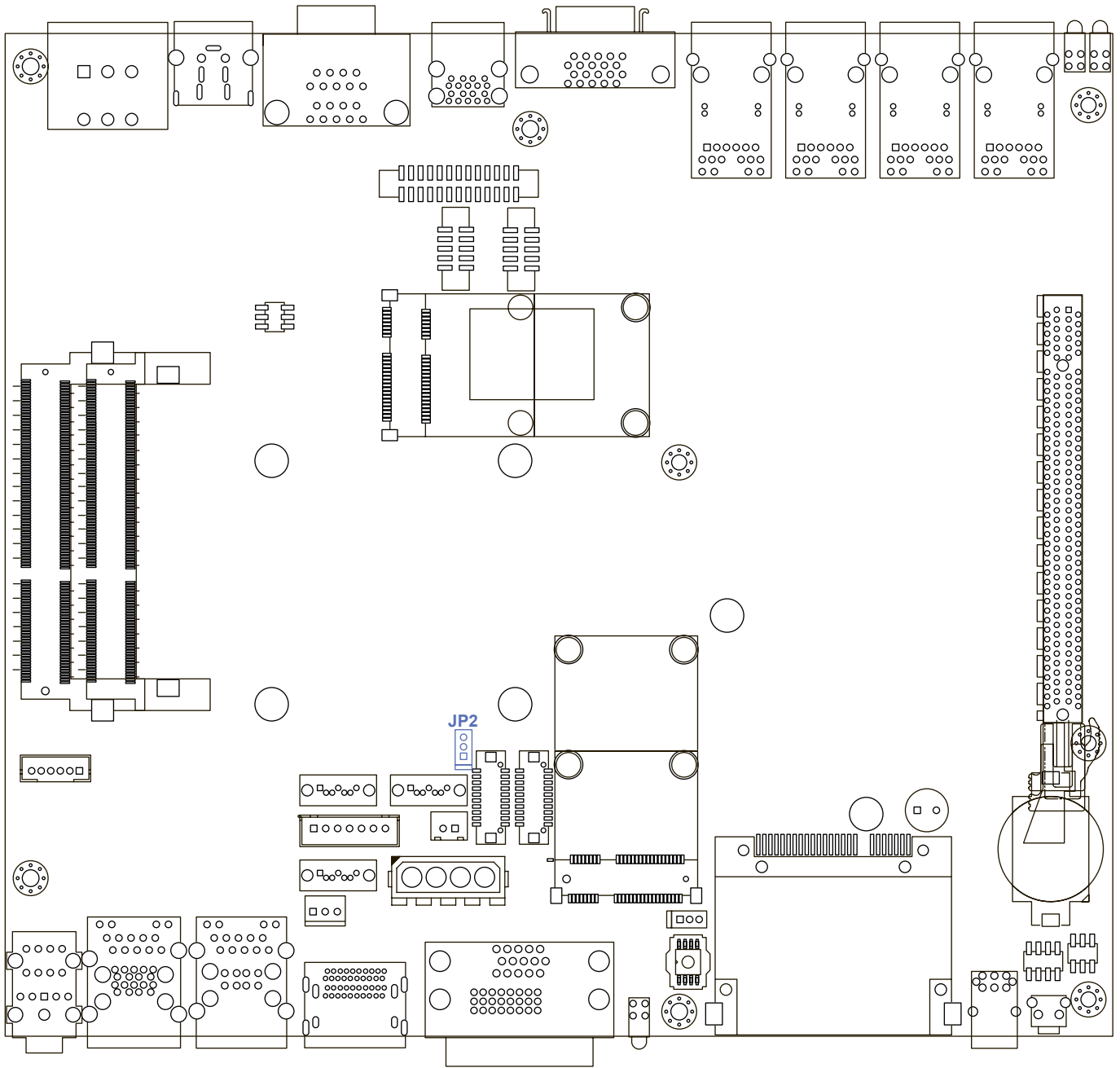

JP1 provides LVDS voltage selection function, closing Pin 1, 2 is for 3.3V LVDS power input; closing Pin 2, 3 is for 5V LVDS power input.

Setting	Description
1-2	+3.3V (Default)
2-3	+5V



## 2.5.2 JP4(A) CMOS Clear Jumper Setting

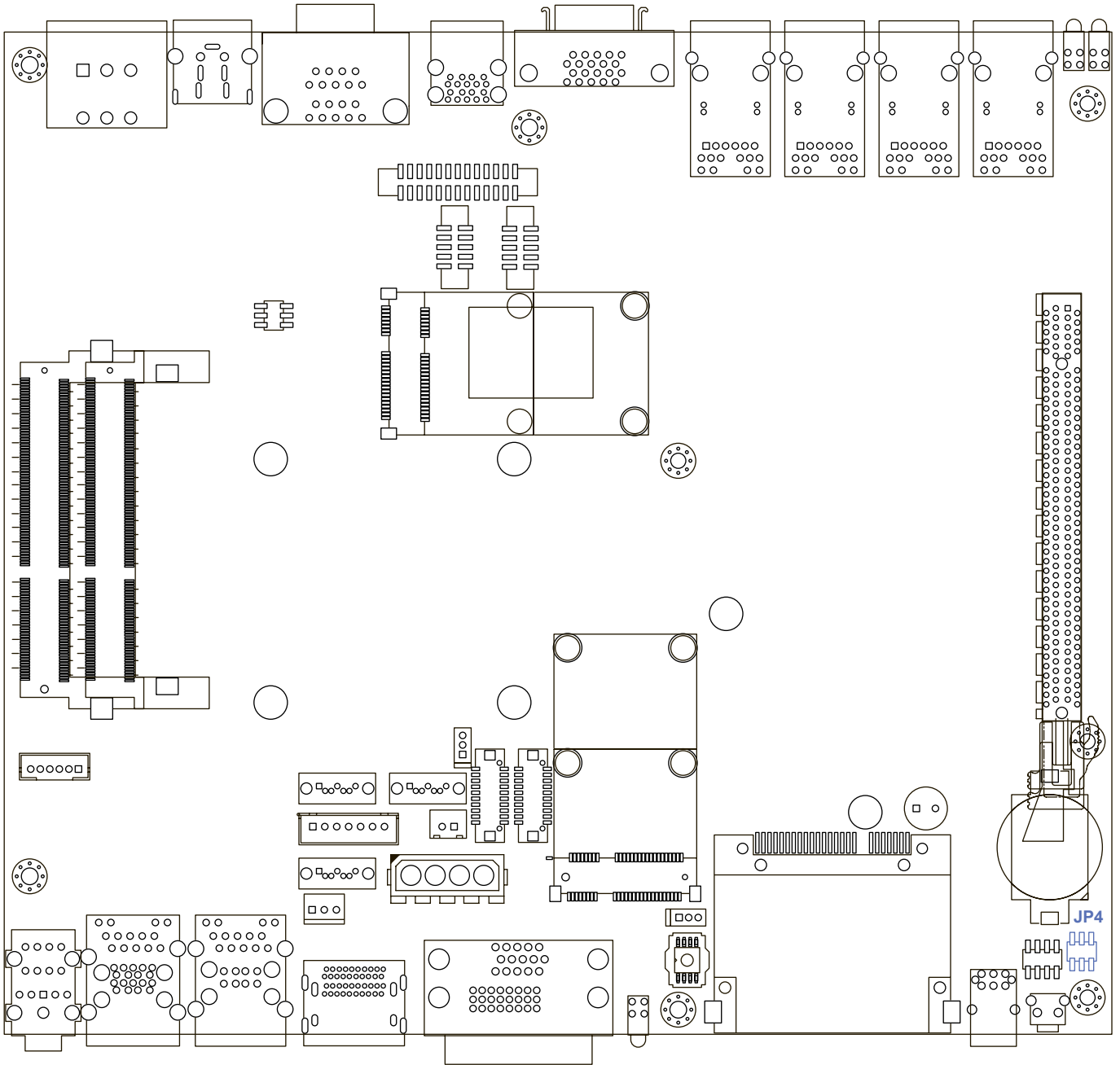

Setting	Description
1-3	Normal (Default)
3-5	Clear CMOS

## 2.5.3 JP4(B) ME Clear Jumper Setting

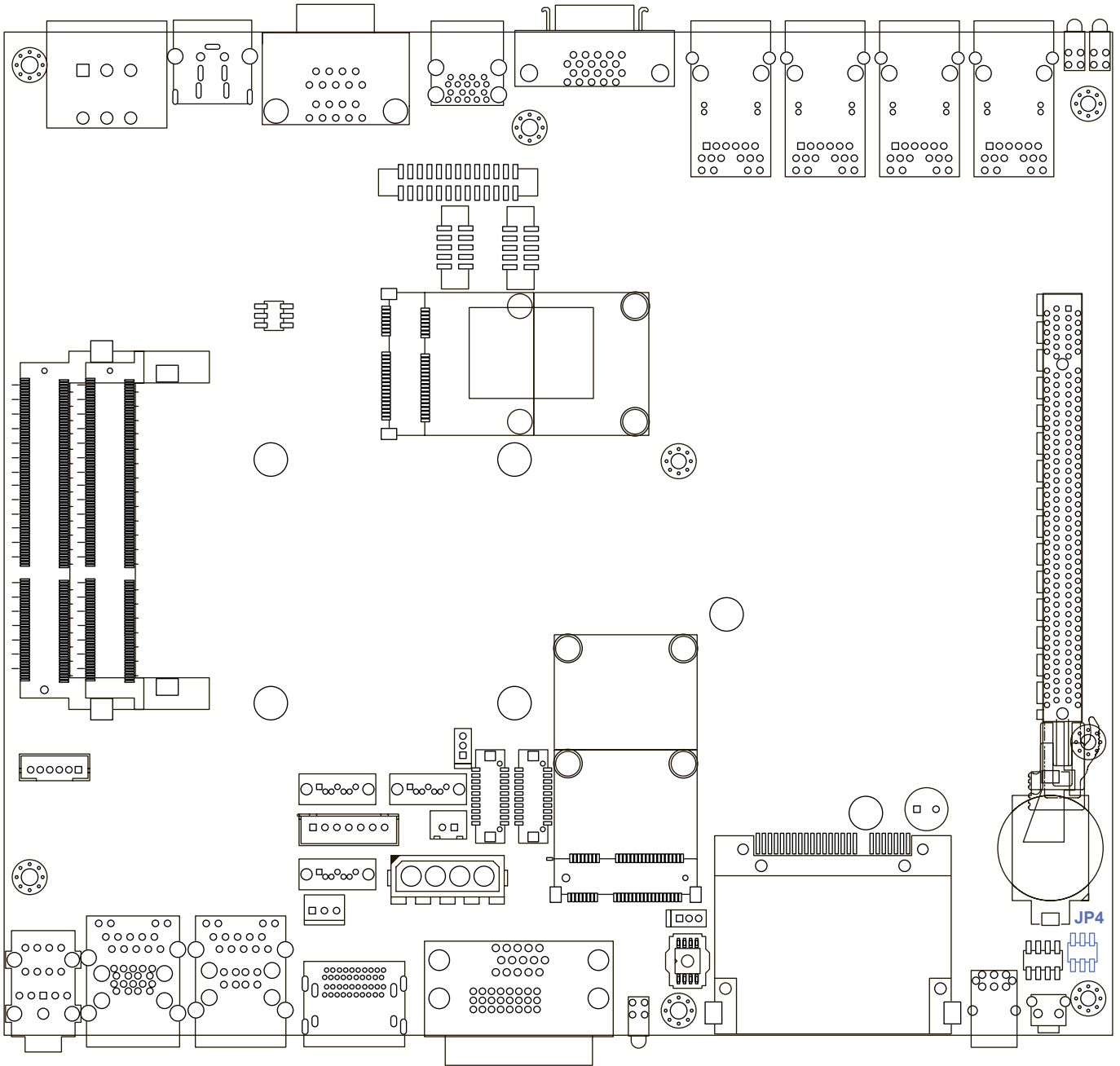

Setting	Description
2-4	Normal (Default)
4-6	Clear ME

## 2.5.4 JP3 AT/ATX Power Mode Jumper Setting

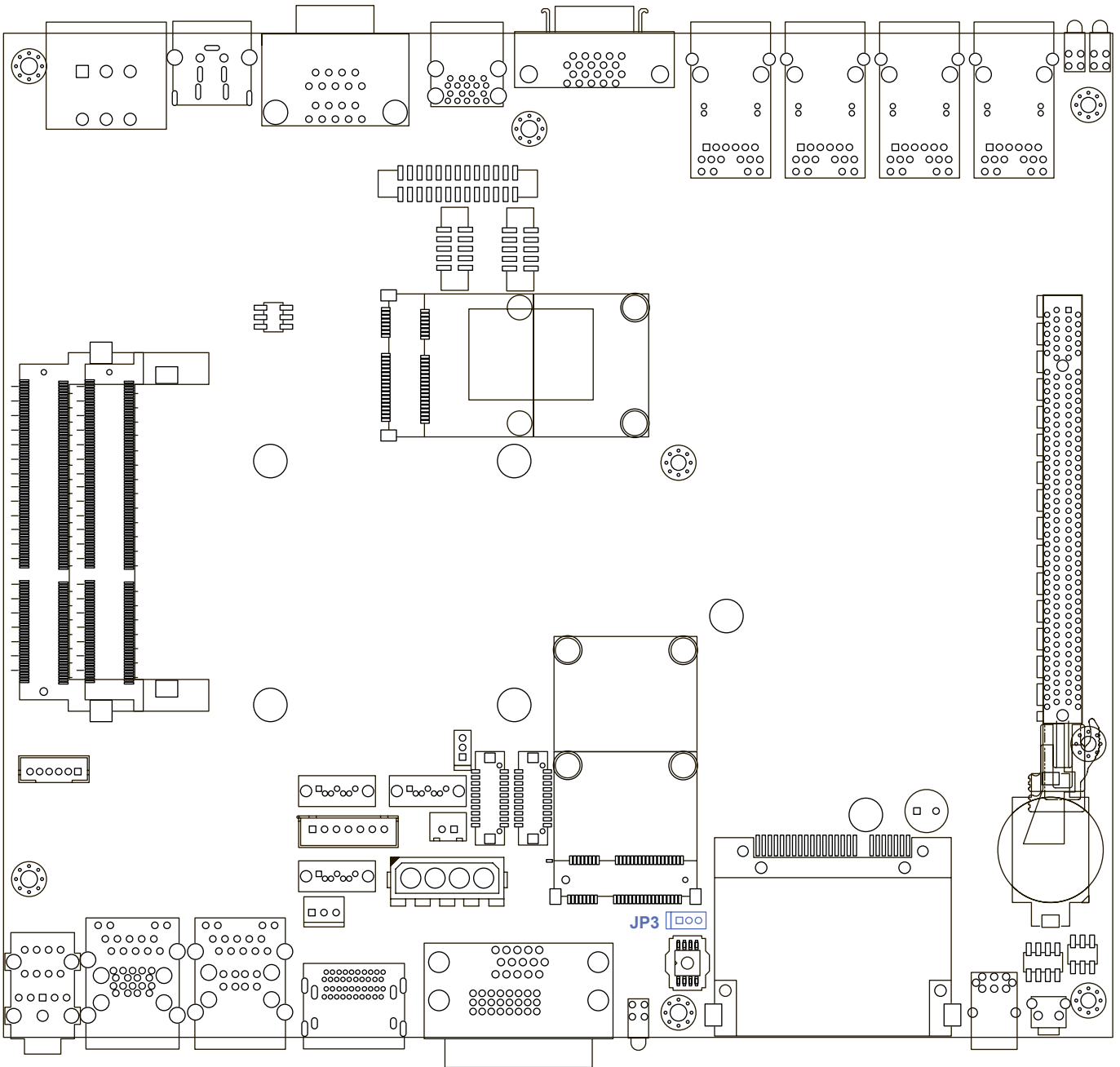

The ECS-7700/7100 series main board contains a jumper that can switch the AT/ATX Power Setting. Normally this jumper should be set with Pin 4 and Pin 6 in ATX power mode. And power on the system by the 2-pin terminal block at the top panel. If you set it with Pin 2 and Pin 4 in AT power mode. It will send the power button signal to power on the system automatically

Setting	Description
1-2	AT Mode
2-3	ATX Mode (Default)

## 2.5.5 JP1 PCIe Bifurcation Jumper Setting

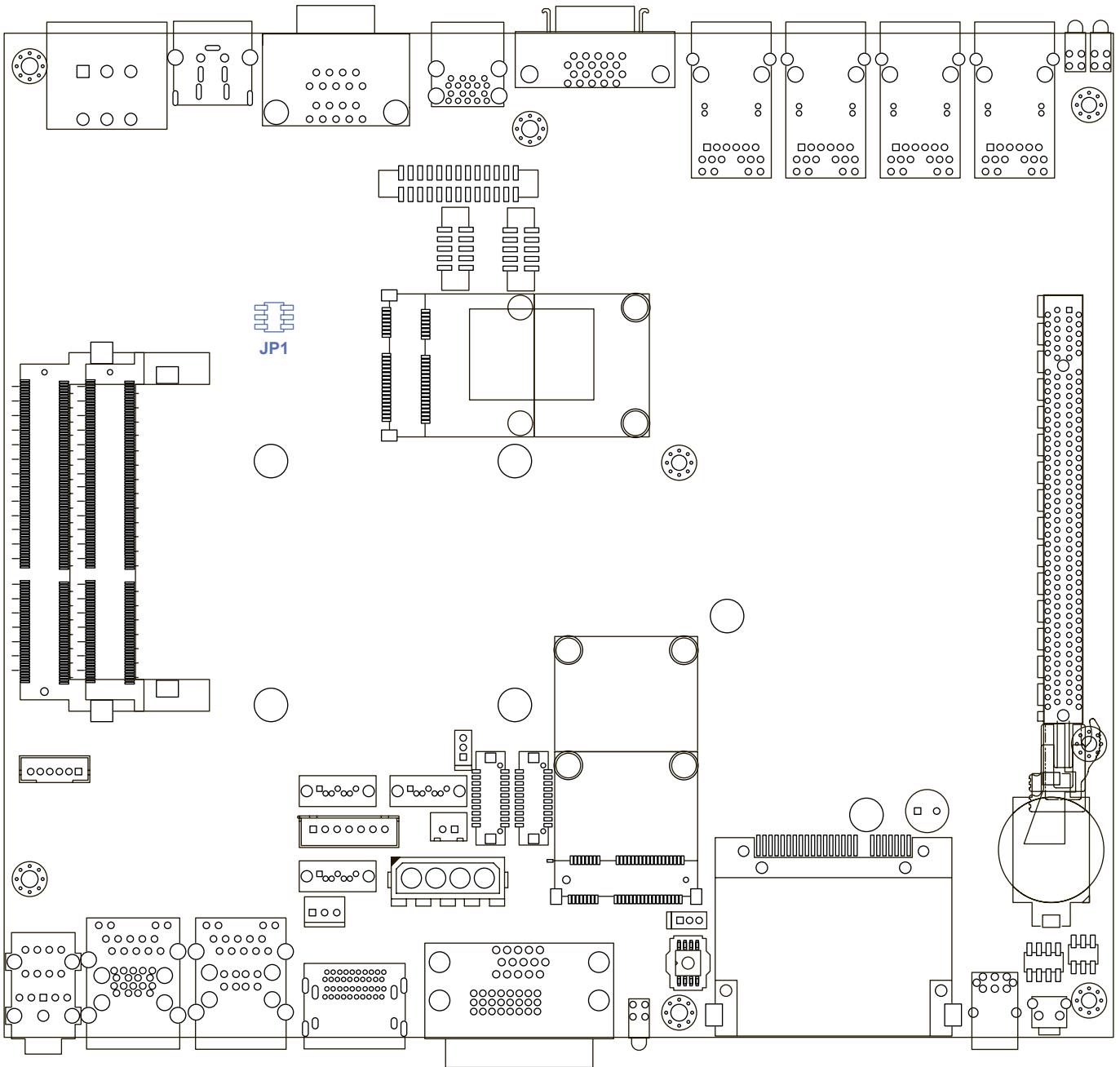

CFG [ 6 : 5 ]	PCle Port bifurcation Straps
	11 : (Default) x16 - Device 1 functions 1 and 2 disabled
	10 : x8, x8 - Device 1 functions 1 enabled ; function 2 disabled
	01 : Reserved - (device 1 functions 1 disabled ; function 2 enabled)
	00 : x8, x4, x4 - Device 1 functions 1 and 2 enabled
JP1	PCle Bifurcation
(2-4) (1-3)	x16 (Default)
(2-4) (3-5)	x8, x8
(4-6) (1-3)	Reserved
(4-6) (3-5)	x8, x4, x4

# 3

## System Setup

### 3.1 Install DDR3 / DDR3L SODIMM Modules

Step1.



Put the ECS-7700/7100 series upside down on a flat surface. First, to loose the front panel screw and the rear panel screw by bare hands, and use a Philips screwdriver to loose 4 M3 flat-head screws on the “back panel”.

Step2.

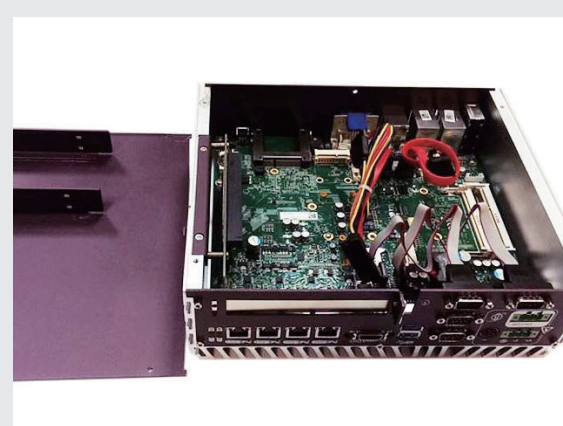

Remove the “back panel” and you can see a SATA cable and DDR3 SODIMM socket exposed.

### Step3.

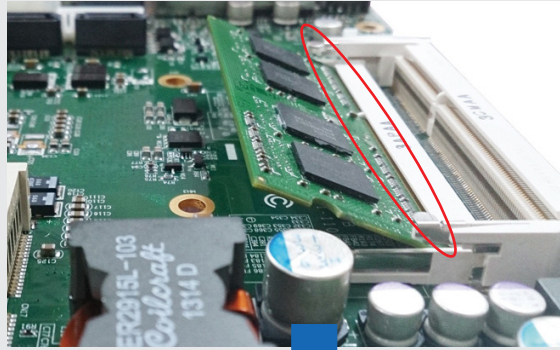

Tile the SODIMM module and insert it to the SODIMM socket.

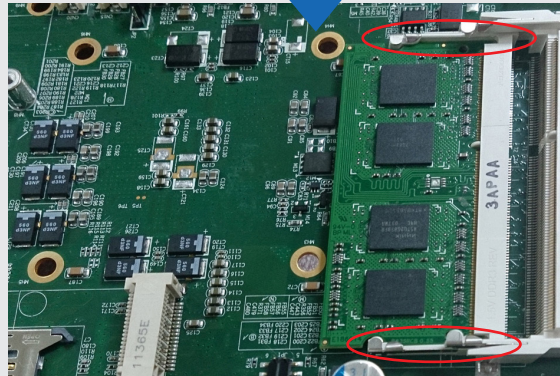

As it's firmly contacted with socket connectors, press it down until the clamps of the socket snap into the latching position of SODIMM module.

## 3.2 Install HDD

### Step1.



Put the ECS-7700/7100 series upside down on a flat surface. First, to loose the front panel screw and the rear panel screw by bare hands, and use a Philips screwdriver to loose 4 M3 flat-head screws on the "back panel".

### Step2.

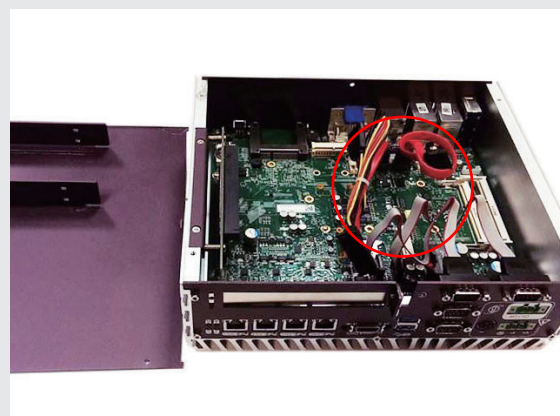

Remove the "back panel" and you can see a SATA cable and DDR3 SODIMM socket exposed.

### Step3.



Find the M3 screws (8pieces) in the accessory box. And prepare one SSD or HDD by your own.

### Step4.

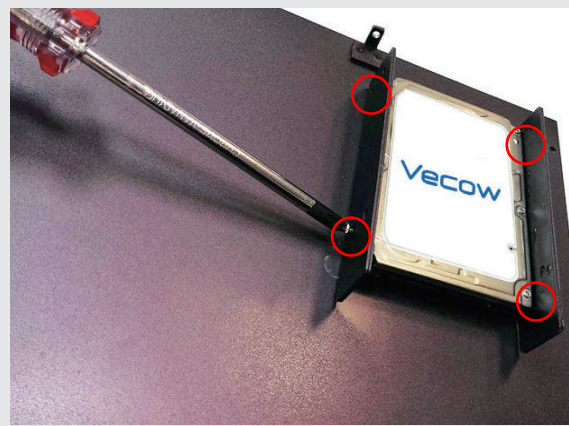

Place the HDD into the bracket and gently push it down to make it contact with thermal pad. Use a Philips screwdriver to fix the HDD with four M3 screws.

### Step5.

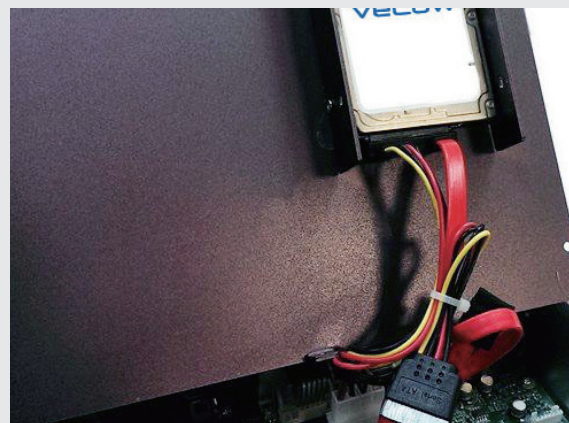

Pull out the SATA cable inside the chassis and connect it to HDD.

## 3.3 Install MiniPCle Cards

### Step1.



Put the ECS-7700/7100 series upside down on a flat surface. First, to loose the front panel screw and the rear panel screw by bare hands, and use a Philips screwdriver to loose 4 M3 flat-head screws on the “back panel”.

### Step2.

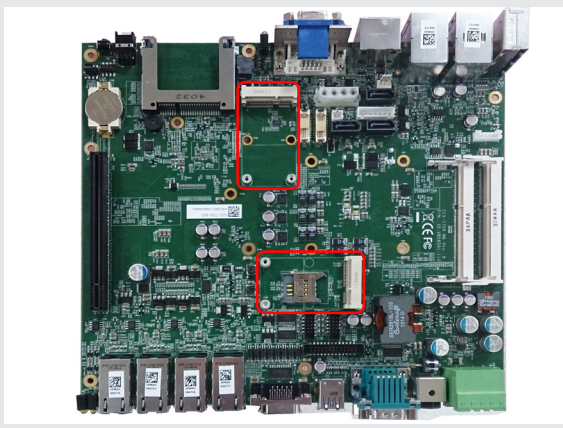

There are 2 Mini-PCle sockets on the main board. Choose one of Mini-PCle socket to put your mini-PCle card in.

### Step3.

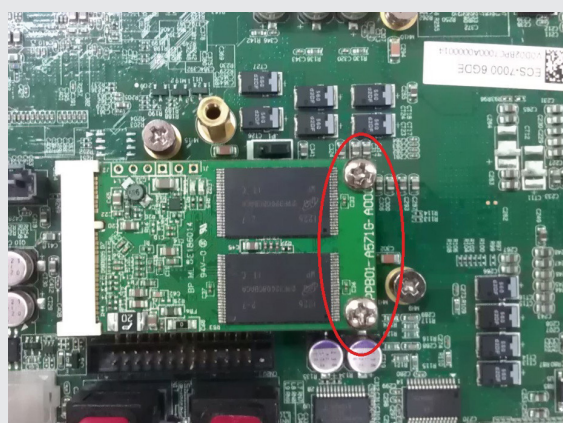

Using 2 BH-M2.5X6 screws to lock your mini-PCle card firmly. Then you can re-screw the back panel as the first step.



### 3.4 Install SATA DOM

Step1.



Put the ECS-7700/7100 series upside down on a flat surface. First, to loose the front panel screw and the rear panel screw by bare hands, and use a Philips screwdriver to loose 4 M3 flat-head screws on the “back panel”.

Step2.

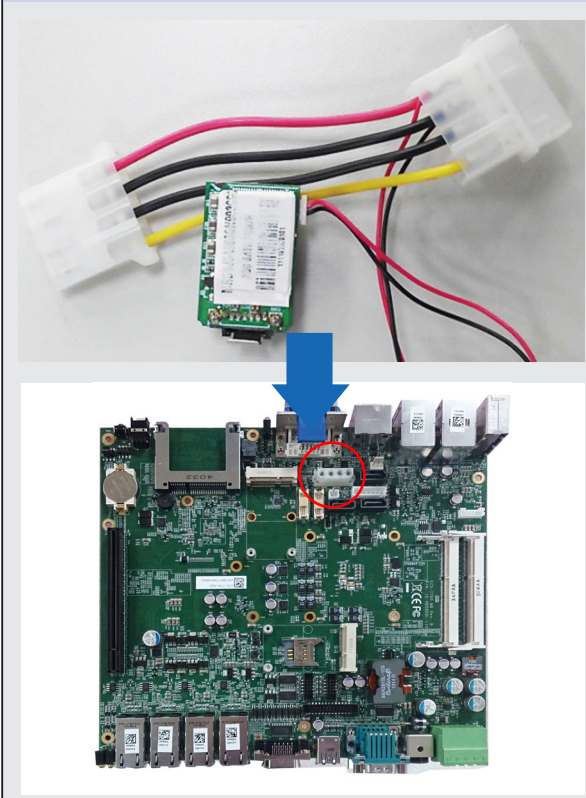

Preparing your SATA DOM and finding a SATA DOM connectors on the main board.

### Step3.

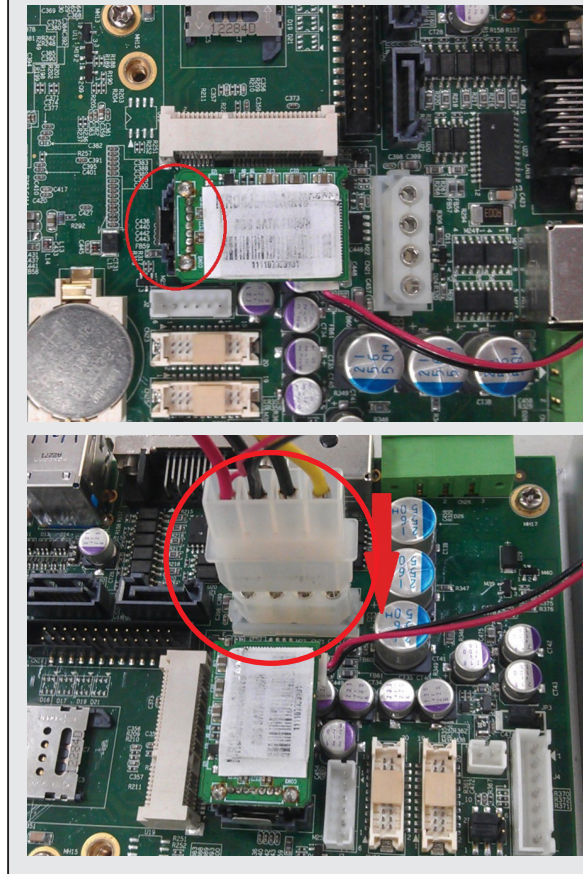

Selecting one of the SATA DOM connector and plug in your SATA DOM. Then you can re-screw the back panel as the first step.

# 3.5 Install PCI or PCIe Card

## Step1.



Put the ECS-7700/7100 series upside down on a flat surface. First, to loose the front panel screw and the rear panel screw by bare hands, and use a Philips screwdriver to loose 4 M3 flat-head screws on the “back panel”.

## Step2.

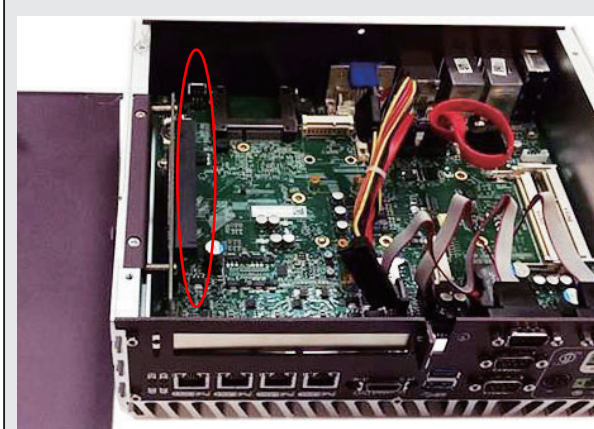

There is one PCI/PCIe socket on the main board.

## Step3.

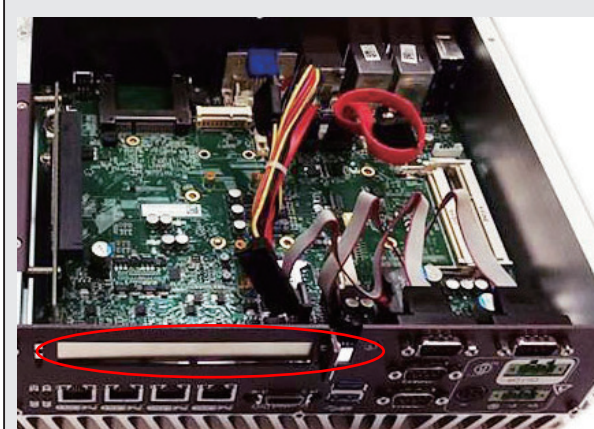

Remove the PCI/PCIe dummy bracket.

Step4.

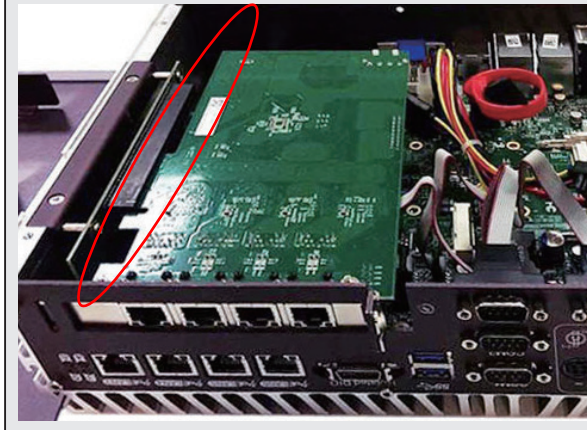

Insert the PCIe/PCI card right on the socket. Then you can re-screw the back panel as the first step.

### 3.5 Mount Your ECS-7700/7100 series

ECS-7700/7100 series is shipped with wall-mount brackets. You can mount your ECS-7700 series on the wall by following the steps listed below.

#### Step1.



Put the ECS-7700/7100 series upside down on a flat surface. Use a Philips screwdriver to loose screw on the back side.

#### Step2.



Find your wall-mounts brackets (2 pieces) in the accessory box.

#### Step3.

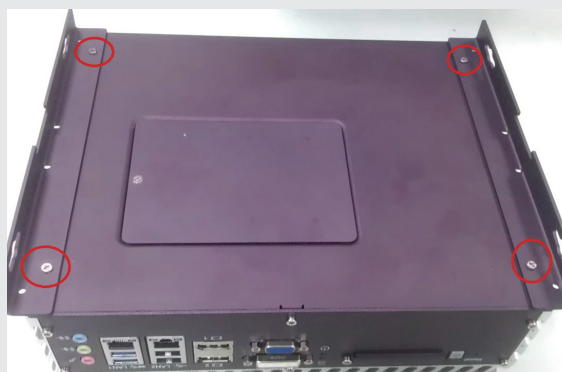

Fix two wall-mount brackets to the chassis with four M4 screws using a Philips screwdriver.

## Installation Method 1

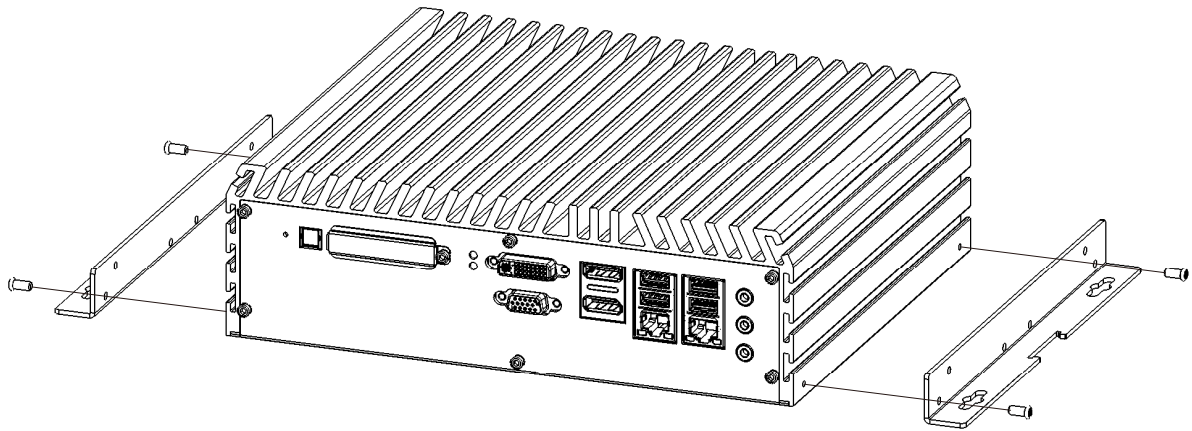

## Installation Method 2

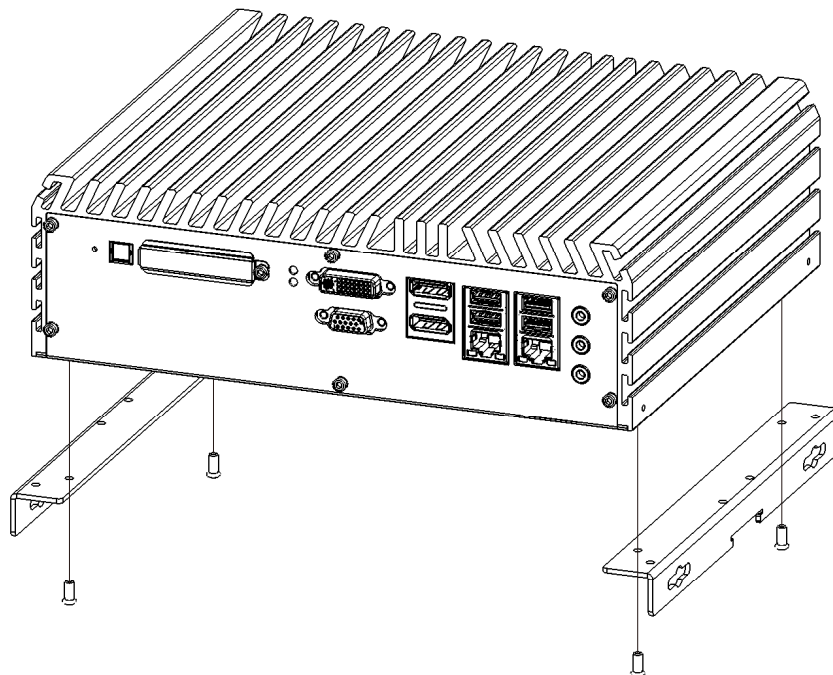

# 4

## BIOS and Driver

### 4.1 BIOS Settings

The board uses UEFI BIOS that is use Serial Peripheral Interface (SPI) Flash. The SPI Flash contains the BIOS Setup program, POST, the PCI auto-configuration utility, LAN, EEPROM information, and Serial port support. The BIOS setup program is accessed by pressing the <Del> key after the Power-On Self-Test (POST) memory test begins and before the operating system boot begins. The menu bar is shown below.



Figure 4.1: BIOS Menu Bar

## 4.1.1 Main Menu

Phoenix SecureCore(tm) Setup Utility					
Main	Advanced	Chipset	Boot	Security	Save & Exit
<b>BIOS Information</b>					Item Specific Help
<b>BIOS Vendor</b>	American Megatrends				
<b>Core Version</b>	4.6.5.3				
<b>Compliance</b>	UEFI 2.3; PI 1.2				
<b>Project Version</b>	1APTJ 0.24 x64				
<b>Build Date and Time</b>	01/24/2013 15:47:32				
<b>Processor information</b>					
<b>Brand String</b>	Intel (R) Core (TM) i7-3610				
<b>System Language</b>	[English]				
<b>System Date</b>	[Thu 02/21/2013]				
<b>System Time</b>	[12:00:00]				
<b>Access Level</b>	Administrator				

Figure 4.2: BIOS Main Screen

**System Time / Date :** Press “TAB” key to switch sub-items of value .Then press “+” key or “-” key number key for modify value.

## 4.1.2 Advanced Function

Phoenix SecureCore(tm) Setup Utility					
Main	Advanced	Chipset	Boot	Security	Save & Exit
<b>ACPI Settings</b>					Item Specific Help
<b>Enable ACPI Auto Configuration</b>	[Disabled]				
<b>Enable Hibernation</b>	[Enabled]				

Figure 4.3: ACPI Setting Setup Screen

**Enable ACPI Auto Configuration:** This system support ACPI function as auto process. You should Enable / Disable that depend as your O.S.



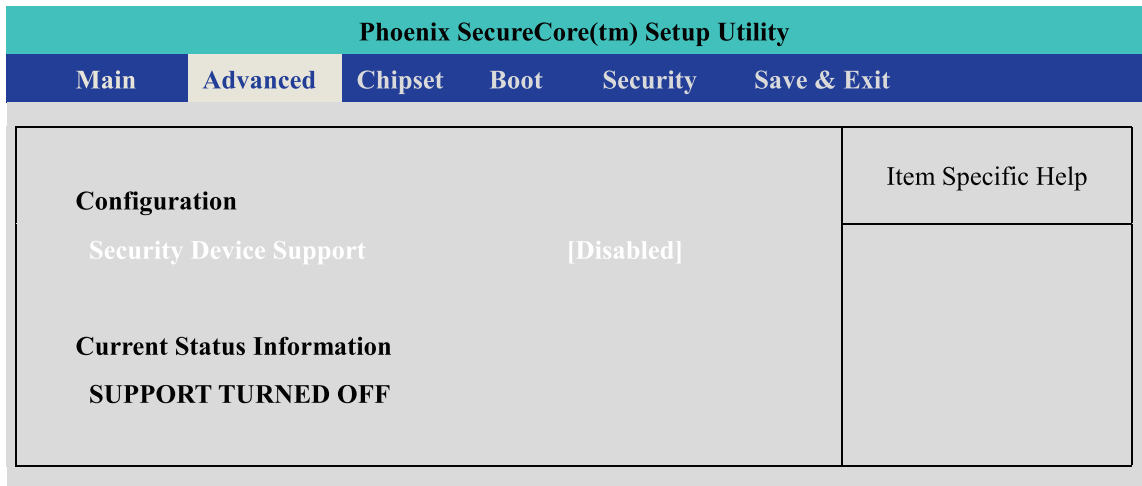

Figure 4.4: Trusted Computing Setup Screen

**Security Device Support** : Enables or Disables BIOS support for security device. O.S. will now show Security Device. TCG EFT protocol and INT1A interface will not be available.

**Current Status Information :**

Show as below option

- SUPPORT TURNED OFF
- SUPPORT TURNED ON

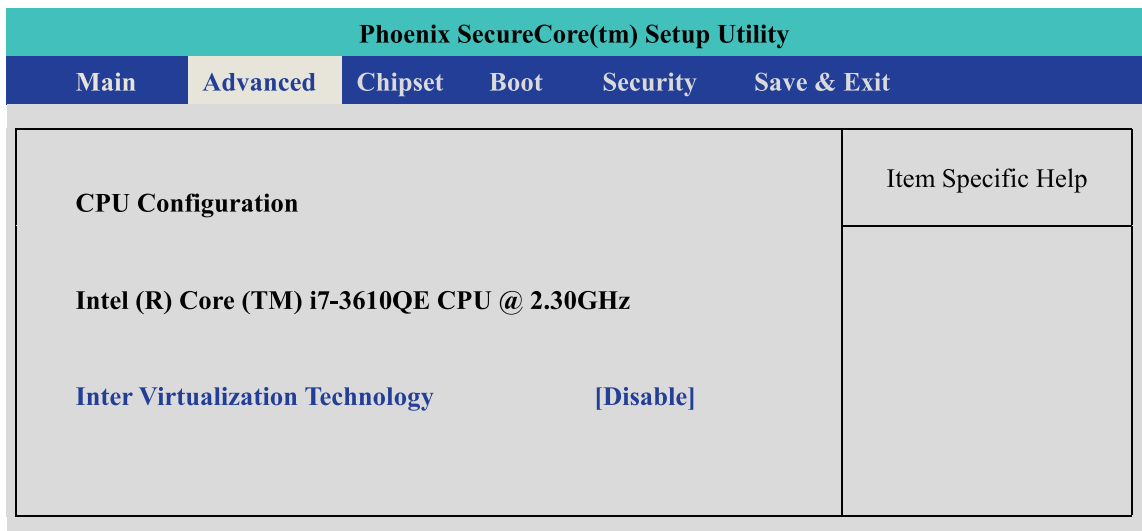

Figure 4.5: Trusted Computing Setup Screen

**Intel Virtualization Technology** : For Virtualization Application or platform usage, when enabled, a VMM can utilize the additional hardware capabilities provided by Vanderpool Technology,

Phoenix SecureCore(tm) Setup Utility						
Main	Advanced	Chipset	Boot	Security	Save & Exit	
SATA Controller(s)					[Enabled]	Item Specific Help
SATA Model Selection					[IDE]	
Serial ATA Port 0					Empty	
Serial ATA Port 1					WDC WD320	
Serial ATA Port 2					Empty	
Serial ATA Port 3					Empty	
Serial ATA Port 4					Empty	
Serial ATA Port 5					Empty	

Figure 4.6: SATA Configuration Setup Screen

**SATA Controller(s) :**

Enables or Disables integrate SATA controller for Storage device use.

**SATA Mode Selection :**

Determines how the SATA transfer mode for operate. Here have three option for choice [IDE] / [AHCI] / [RAID]. For the RAID mode operate, please see appendix E. for detail information.

**Serial Port 0~5 :**

This system offers six SATA port for connection SATA device.

**Advanced->IT8783F Super IO Configuration->Serial Port 1**

Phoenix SecureCore(tm) Setup Utility						
Main	Advanced	Chipset	Boot	Security	Save & Exit	
Serial Port 1 Configuration						Item Specific Help
Serial Port					[Enabled]	
Device Settings					IO=3F8h; IRQ=4;	
Change Settings					[IO=3F8h; IRQ=4;]	

Figure 4.7: Serial Port 1 Setup Screen

**Serial Port :**

Enable or Disable Serial Port .

**Device Setting:**

Current IO address and interrupt resource of Serial Port.

**Change Settings :**

Select another device setting .

Here have 4 option :

IO=3F8h; IRQ=4;

IO=2F8h; IRQ=3;

IO=3E8h; IRQ=10;

IO=2E8h; IRQ=11;

**Advanced->IT8783F Super IO Configuration->Serial Port 2**

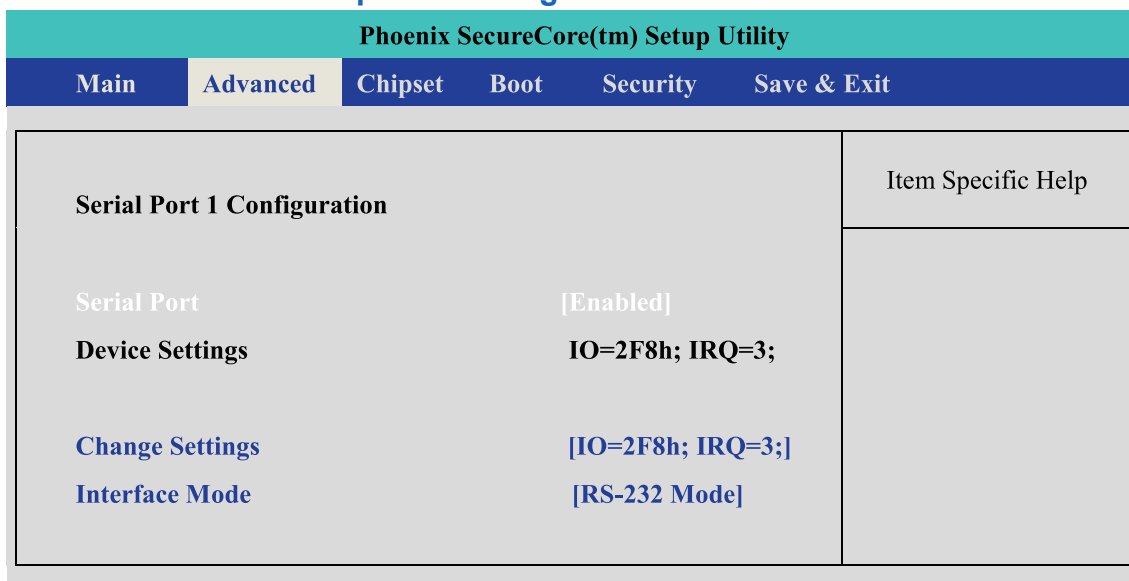

Figure 4.8: Serial Port 2 Setup Screen

**Serial Port :**

Enable or Disable Serial Port .

**Device Setting:**

Current IO address and interrupt resource of Serial Port.

**Change Settings :**

Select another device setting .

Here have 4 option :

IO=3F8h; IRQ=4;

IO=2F8h; IRQ=3;

IO=3E8h; IRQ=10;

IO=2E8h; IRQ=11;

**Interface Mode:**

Here have 4 option :

RS-232 Mode

RS-422 Mode

RS-485 Mode

## Advanced->IT8783F Super IO Configuration->Serial Port 3

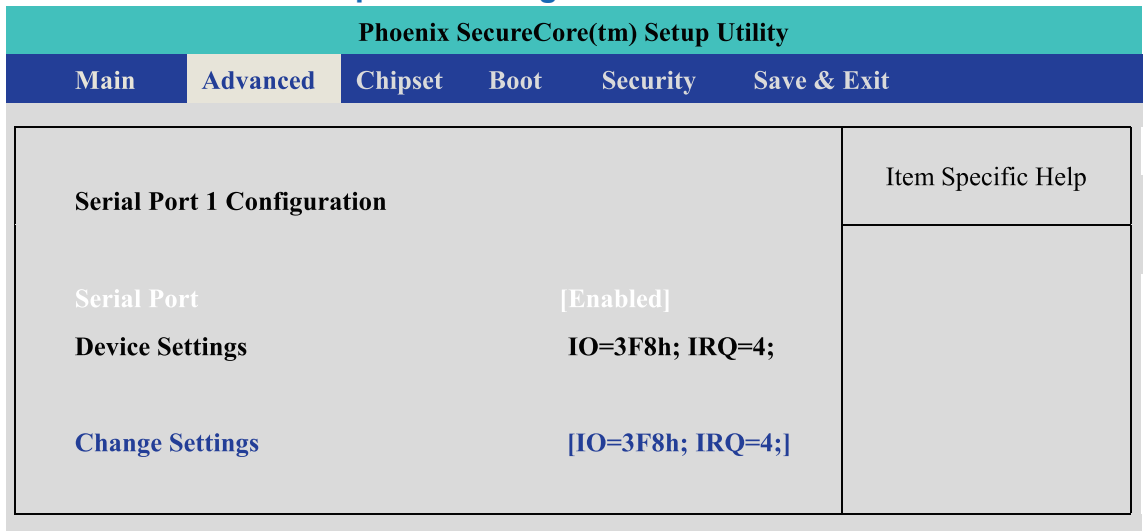

Figure 4.9: Serial Port 3 Setup Screen

### Serial Port :

Enable or Disable Serial Port .

### Device Setting:

Current IO address and interrupt resource of Serial Port.

### Change Settings :

Select another device setting .

Here have 4 option :

IO=3F8h; IRQ=4;

IO=2F8h; IRQ=3;

IO=3E8h; IRQ=10;

IO=2E8h; IRQ=11;

IO=2F0h; IRQ=6;

IO=2E0h; IRQ=7;

## Advanced->IT8783F Super IO Configuration->Serial Port 4

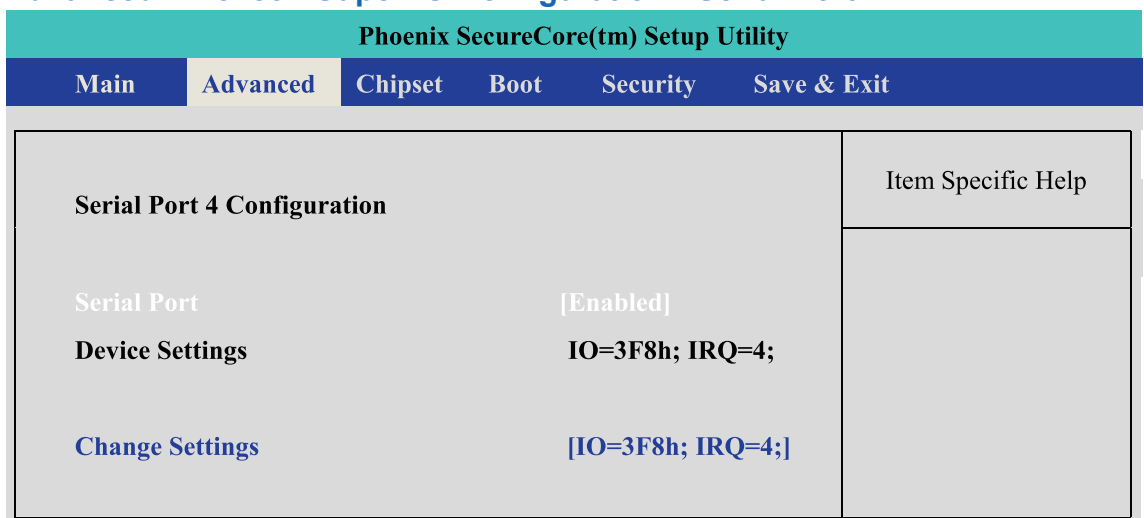

Figure 4.10: Serial Port 4 Setup Screen

### Serial Port :

Enable or Disable Serial Port .

### Device Setting:

Current IO address and interrupt resource of Serial Port.

### Change Settings :

Select another device setting .

Here have 4 option :

IO=3F8h; IRQ=4;

IO=2F8h; IRQ=3;

IO=3E8h; IRQ=10;

IO=2E8h; IRQ=11;

IO=2F0h; IRQ=6;

IO=2E0h; IRQ=7;

## 4.1.3 Chipset Function



### WOL configuration

Chipset->PCH-IO Configuration->Wake on LAN

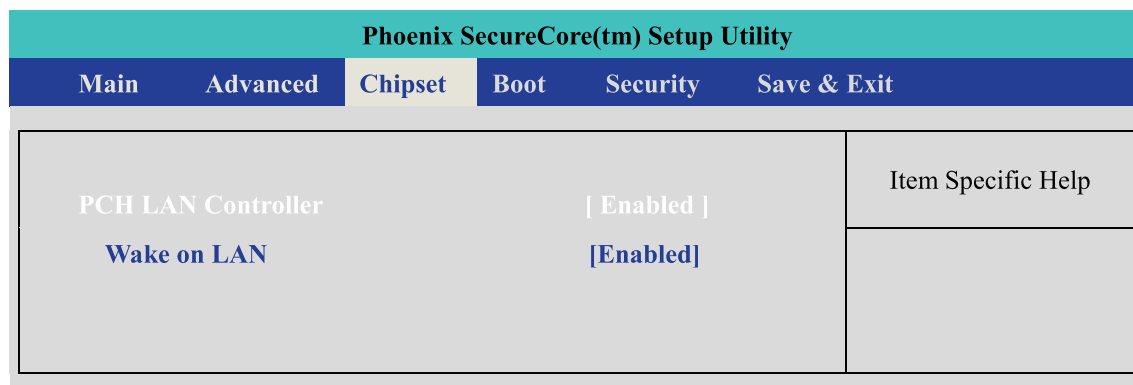

Figure 4.11: Network Setup Screen

**PCH LAN Controller** : Enable or Disable Serial Port .

**Wake on LAN** : Enable or Disable integrated LAN to wake the system.  
This function also can active by O.S.

### Power Loss Configuration

Chipset->PCH-IO Configuration->Restore AC Power Loss

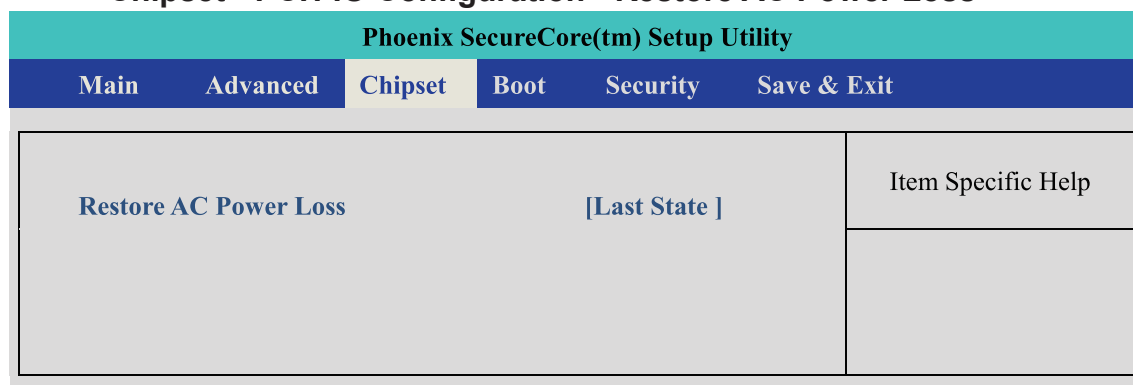

Figure 4.12: Power Loss Setu Screen

## PCH LAN Controller :

[Power Off ] : When plug-in the power source , system will keep on SB mode.

[Power On ] : When plug-in the power source , system will auto booting .

[Last State ] : When plug-in the power source , system will keep on last power status.

### 4.1.4 Boot Function



#### Boot Option

Chipset->PCH-IO Configuration->Wake on LAN

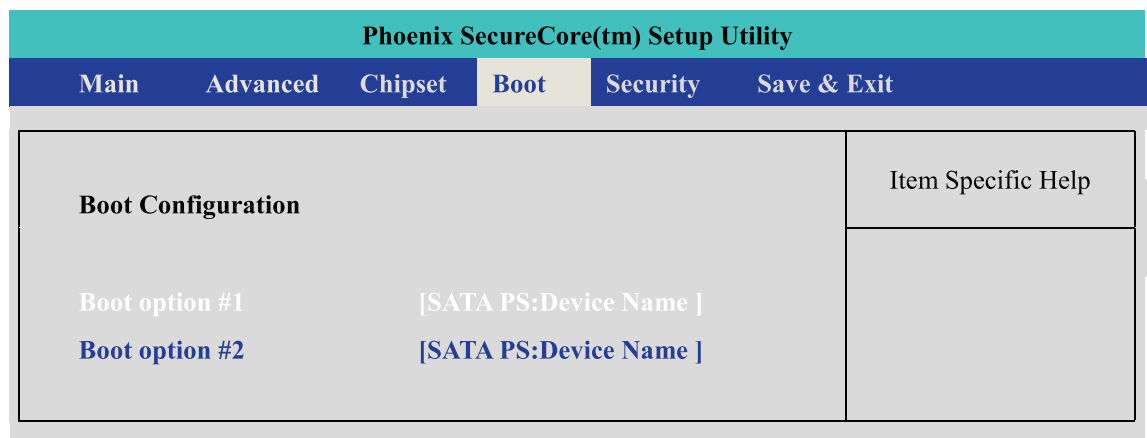

Figure 4.13 Boot Setup Screen

**Boot option :** When you press “Enter” , you can select which device you would like to boot.

## 4.2 Operating System

### Linux :

Ubuntu 10.04LTS or Above

Fedora 13 or Above

And another Linux kernel 2.6.33 and RHL6.0

(\* The Linux kernel of RHL , please check RadHat website first )

### Windows :

Windows XP

Windows 7 Home/Professional/MediaCenter/

Windows 8 ( Do not support RT version)

Windows Server 2008 R2

Windows Server 2012

## 4.3 Driver Installation

After you setup all hardware and firmware device, you should install the correspond Software driver then active O.S process. When you start to install the driver , please make sure you have administrator ID for system authenticate.

Please follow below sequence for driver install

1. Intel Chipset
2. Intel HD 4000 Graphics
3. Network Device – Include 85574L and 82579LM
4. Audio Driver
5. USB 3.0 support
6. Storage: Include “ACHI” driver and Intel Rapid Storage Software.
7. AMT function of Intel ME(Management Engine)

### 4.3.1 Chipset Driver Installation

This device software installs all components of ECS-7000 platform chipset to the system target system. After install this software, please ensure that as following features function properly:

1. PCIe / PCI . ISAPNP services config.
2. IDE/ACHI storage interface Support
3. USB Support
4. Identification of Intel Chipset Components in the Device Manager.

Install instruction:

#### Step1.

Find the driver install file

- Windows 7 64bit version :  
**The Chipset driver location is : [CD]:\Win7\64bit\ChipsetDriver\**

#### Step2.

Execute and install the files which matches your operation system. Instruction windows will pop-up when you start to setup the driver, please follow it and complete the setup processes.

#### Step3.

Once you completed the Intel Chipset Driver setup, please reboot your system , all update function will be active on next time into Windows.

### 4.3.2 Intel HD 4000 Graphics Driver Installation

This driver will install following features or function properly:

- Display serve
- High definition Audio support

Install instruction:

#### Step1.

Find the driver install file

- Windows 7 64bit version :  
**The Graphics driver location is : [CD]:\Win7\64bit\  
VGADriver\**

#### Step2.

Execute and install the files. Instruction windows will pop-up when you start to setup the driver, please follow it and complete the setup processes.

#### Step3.

Once you completed the HD Graphics Driver Driver setup, please reboot your system , all update function will be active on next time into Windows.

### 4.3.3 Network Device Driver Installation

This driver will install following features or function properly:

- LAN 1 : Intel 82579LM network device
- LAN 2~ LAN 6 : Intel 82574L network device.  
( Please ensure your LAN port number)

Install instruction:

#### Step1.

Find the driver install file

- Windows 7 64bit version :  
**The network driver location is : [CD]:\Win7\64bit\LanDriver\**

#### Step2.

Execute and install the files. Instruction windows will pop-up when you start to setup the driver, please follow it and complete the setup processes.



#### Step3.

Once you finish the LAN device Driver setup , the LAN connection will loss for a while and then restart automatically.

#### Step4.

If you need active AMT function as well , please refer to the section of “AMT driver install”.

### 4.3.4 Audio Driver Installation

This driver will install Realtek High definition device software and Utility.

#### Step1.

Find the driver install file

**The Audio driver location is : [CD]:\Win7\64bit\Audio\**

#### Step2.

Execute the install file and start to install it.

#### Step3.

Once you finish the Audio device Driver setup ,please reboot your system , all update function will be active on next time into Windows.

### 4.3.5 USB 3.0 Driver Installation

This driver will install USB 3.0 device support software.

#### Step1.

Find the driver install file

**USB 3.0 driver location is : [CD]:\Win7\64bit\USB3.0**

#### Step2.

Execute the install file and start to install it.

#### Step3.

Once you finish the USB3.0 device Driver setup ,please reboot your system , all update function will be active on next time into Windows.

### 4.3.6 Storage Support Software Installation

Installing the Intel Rapid software

This driver will install following features or function properly:

CAUTION!

This function only use on AHCI mode.  
- Software panel for SATA device  
- Utilities for RAID volume creating.

CAUTION!

#### Step1.

Find the driver install file

**Intel Rapid software location is : [CD]:\Win7\64bit\Storage**

#### Step2.

Execute the install file and start to install it.

#### Step3.

Once you finish the Rapid software setup ,please reboot your system , all update function will be active on next time into Windows.

### 4.3.7 Intel AMT Function Support

This driver will install following features or function properly:

- Intel ME (Management Engine) support
- Intel AMT software panel
- SOL(Serial on LAN) device driver .

#### Step1.

Find the driver install file

**The Chipset driver location is : [CD]:\Win7\64bit\LanDriver\ME**

#### Step2.

Execute the install file and start to install it.

#### Step3.

Once you finish the AMT function setup ,please reboot your system , all update function will be active on next time into Windows.

# A

## ppendix A : Isolating DIO Guide

### ■ Description:

Initialize hardware and resources, and get number of functional boards.

### Syntax:

```
I16 _mnet104_open ()
```

### Argument:

Name	Type	Description
N/C		

### Return:

Return Value	Description
ERR_NoError	The function finished execution successfully.
Other	Please reference to the Appendix error table.

### ■ Description:

Get the local DI value.

### Syntax:

```
I16 _mnet104_read_port( U16 Offset, U8 *Val )
```

### Argument:

Name	Type	Description
Offset	U16	Pointer the access DI port address
Val [output]	U8 *	Return the value of local input interface.

### Return:

Return Value	Description
ERR_NoError	The function finished execution successfully.
Other	Please reference to the Appendix error table.

### ■ Description:

Get the local DI value.

### Syntax:

```
I16 _mnet104_write_port( U16 Offset, U8 Val )
```

**Argument:**

Name	Type	Description
Offset	U16	Pointer the access DI port address
Val	U8	Write the value of local input interface.

**Return:**

Return Value	Description
ERR_NoError	The function finished execution successfully.
Other	Please reference to the Appendix error table.

# A

## Appendix B : GPIO & WDT Function

The GPIO& WDT are using internal Super IO function. However, you must entry super I/O configuration mode to set it.

The output port is set as GPIO 1 on CN13 , reg. index = **0x60**

The input port is set as GPIO 4 on CN12 , reg. index = **0x62**.

Super I/O special address port = **0x2E**

Super I/O special data port = **0x2F**

GPIO Logical device is 0x07

### A. Entry MB PnP Mode

//write twice 0x87 value.

```
outportb(Super I/O special address port, 0x87);
outportb(Super I/O special address port, 0x01);
outportb(Super I/O special address port, 0x55);
outportb(Super I/O special address port, 0x55);
```

### B. Located on Logical Device 7

//write 0x07 on Reg [0x07] , this setup must follow Step A. that can be workable.

```
outportb(Super I/O special address port, 0x07);
outportb(Super I/O special data port, 0x07);
```

### C. Access the Super I/O Register

**Base control for write Super I/O register.**

```
outportb(special address port, Register Index.);
outportb(special data port, update_value);
```

**Base control for read Super I/O register**

```
outportb(special address port, Register Index.);
inportb(special data port); //It will return a BYTE value.
```

### D. Start to Access the ECS-7700/7100 Series GPIO Port

Please refer to source code for set\_data() and get\_data() function.

**Write data to GPO(output) port**

```
set_data( Register Index , update_value);
```

example :

```
unsigned char data = 0x82;
```

```
set_data( 0xE5 , data);
```

```
//Set bit 7 & bit 1 of GPO output port as High level ,another bit is Low
```

Please refer to source code for set\_data() and get\_data() function.

#### **Read data to GPI(input) port**

get\_data( Register Index ) //It will return a BYTE value.

example :

unsigned char data

get\_data( 0xF1 , data);

//Get GPI(input) port status on input\_data variable.

## **E.WDT ON/OFF and Timer-Counter setting**

Refer to GPIO setting of Step A and B. , located Logical 0x08 for WDT function.

Reg [0x30] is WatchDog ON/OFF control.

**WatchDog On** : set\_data( 0x30 , 0x01);

**WatchDog Off** : set\_data( 0x30 , 0x00);

Reg [0xF0] is WatchDog timer - counterON/OFF control.

**WatchDog counter start** : set\_data( 0xF0 , 0x02);

**WatchDog counter stop** : set\_data( 0xF0 , 0x00);

Reg [0xF1] is WatchDog time-out value, "Reading" this register returns the current value in the Watch Dog Counter, not the Watch Dog Timer Time-out value.

**WatchDog time-out value** : set\_data( 0xF1 , );